

# Design and Communication Graphics

## Ordinary Level Solutions

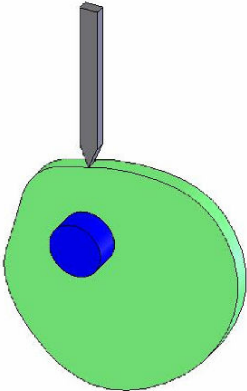

Question 1

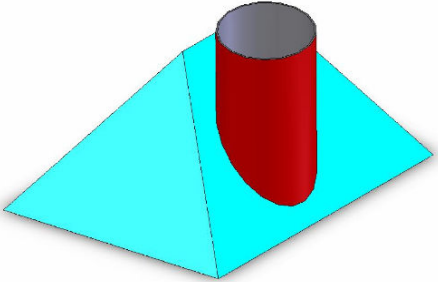
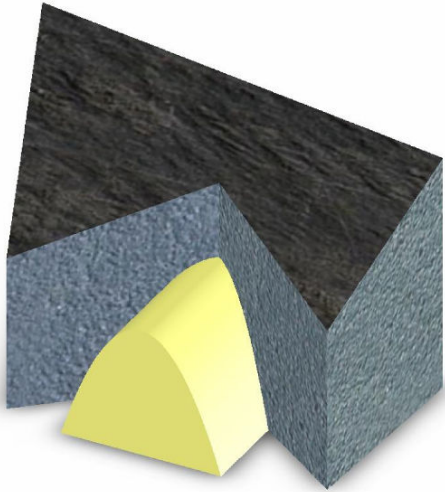
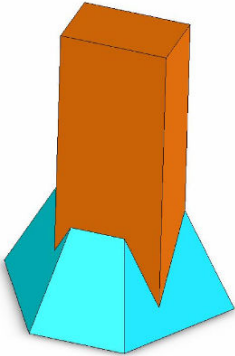
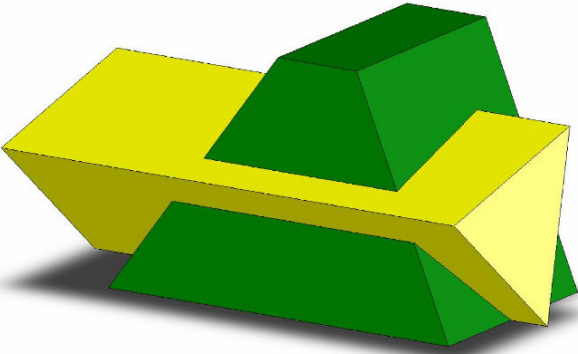
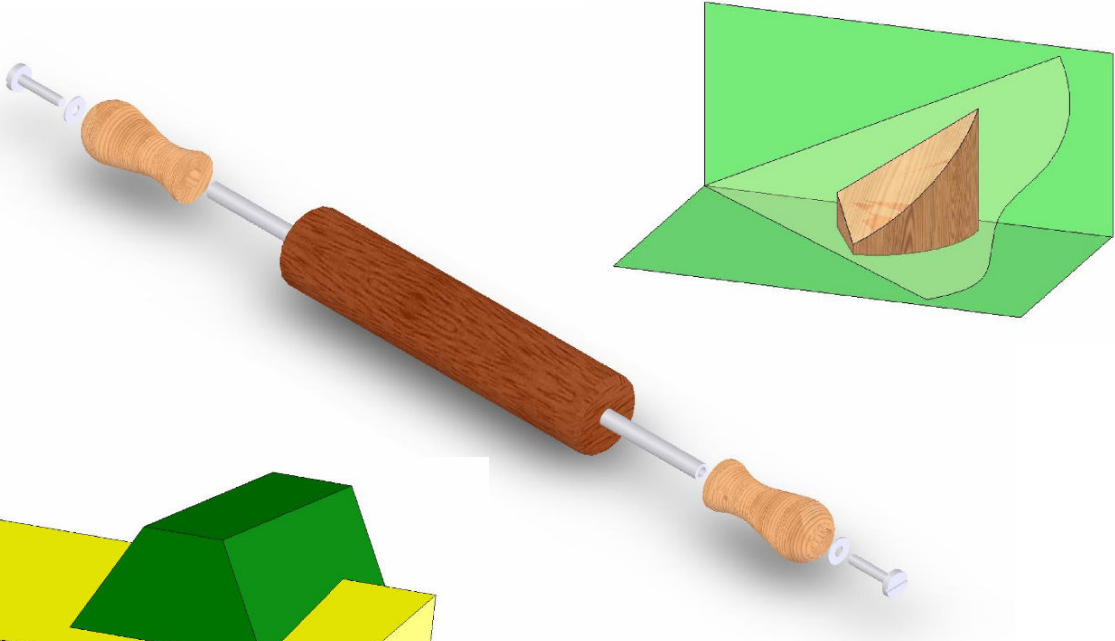
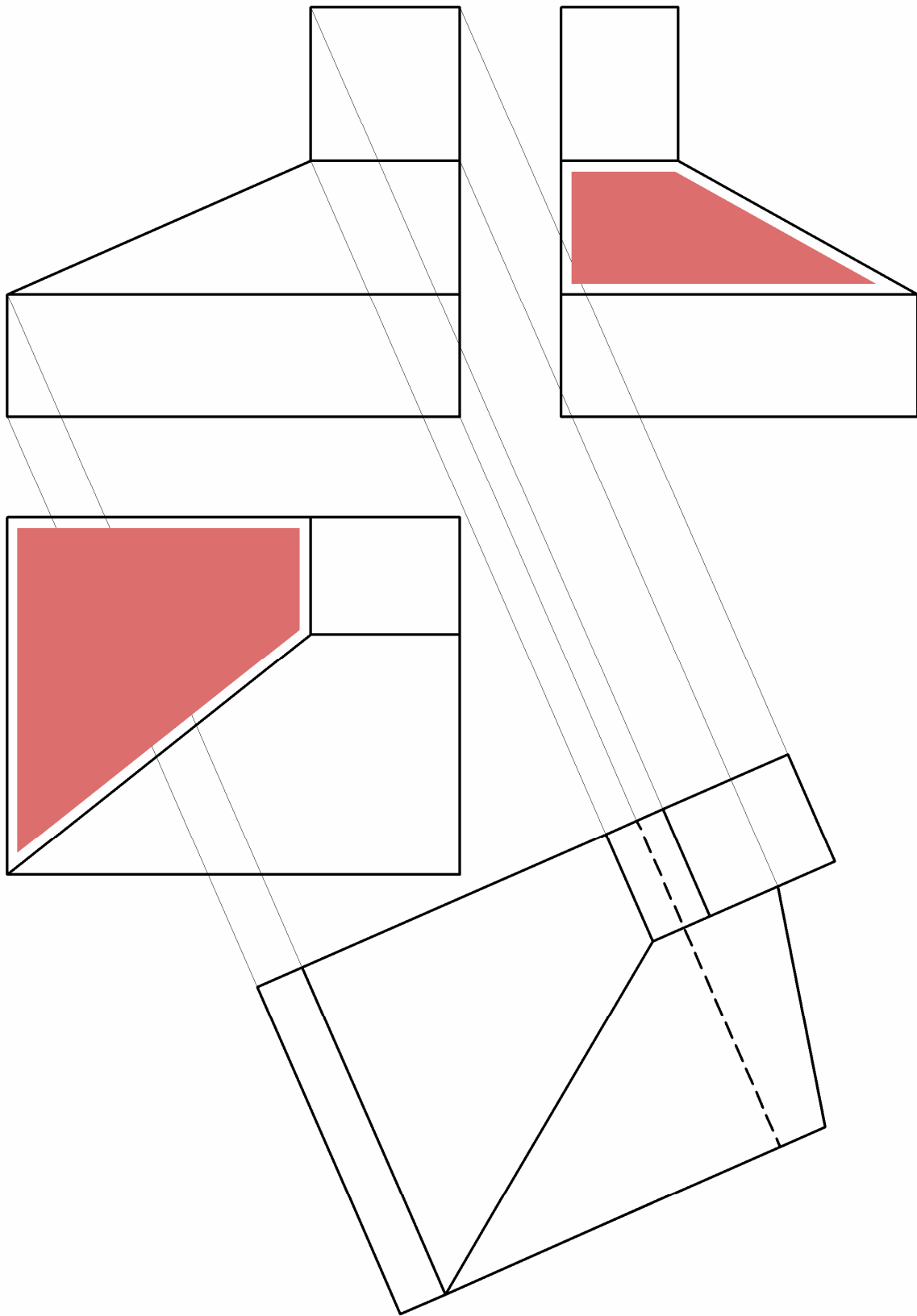

Question 2

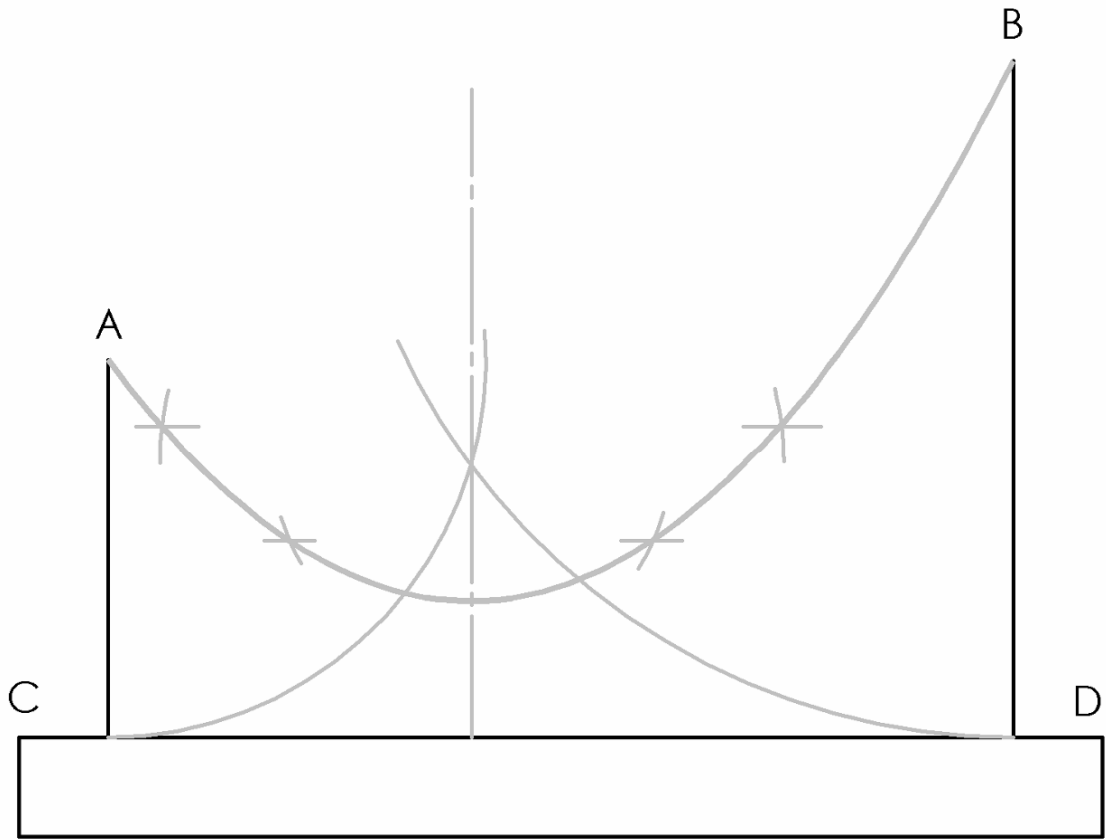

Question 3

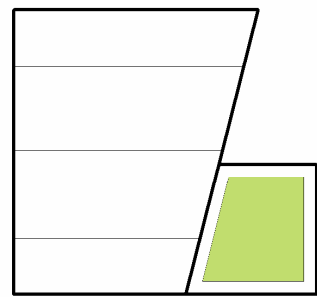
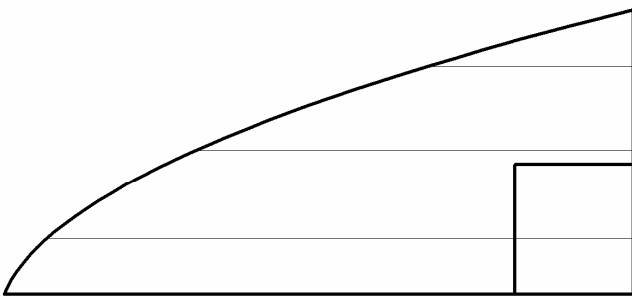
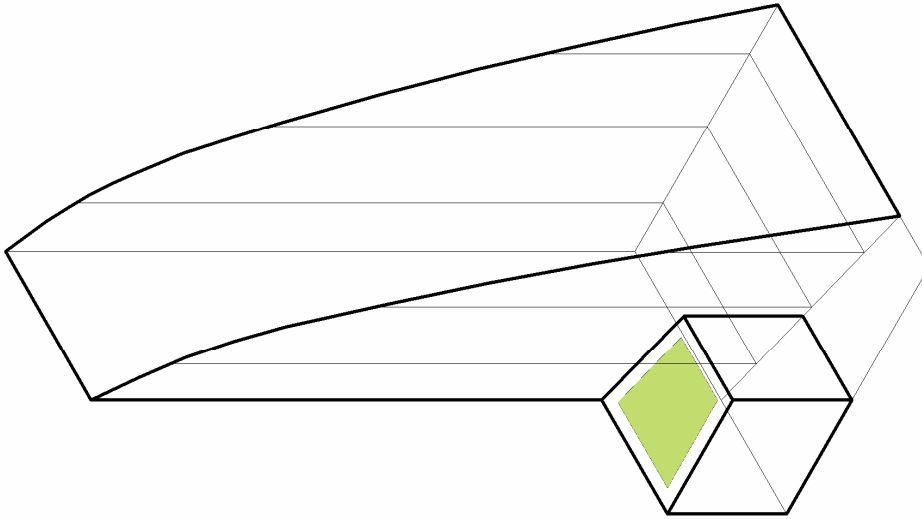

Question 4

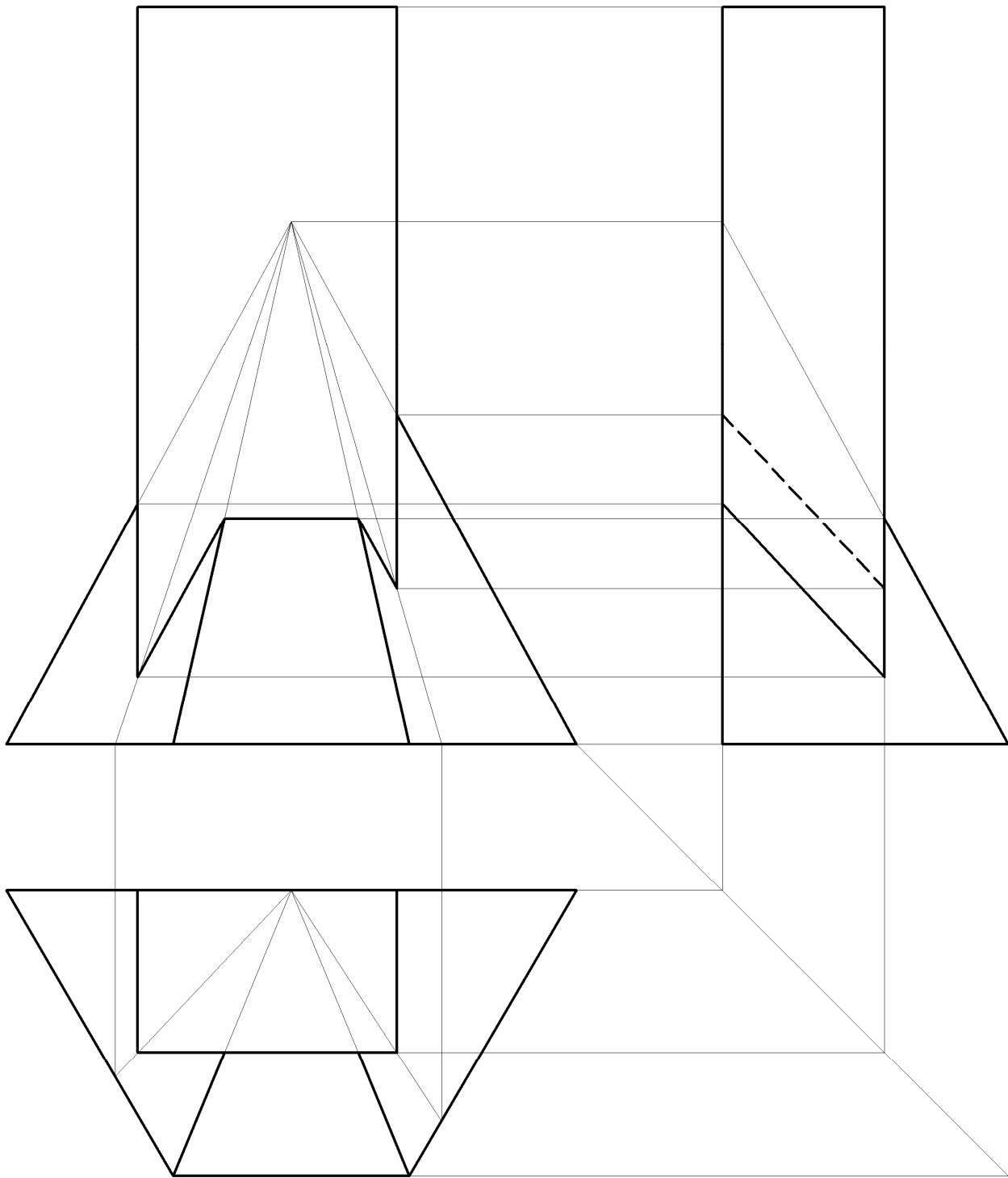

Question 5

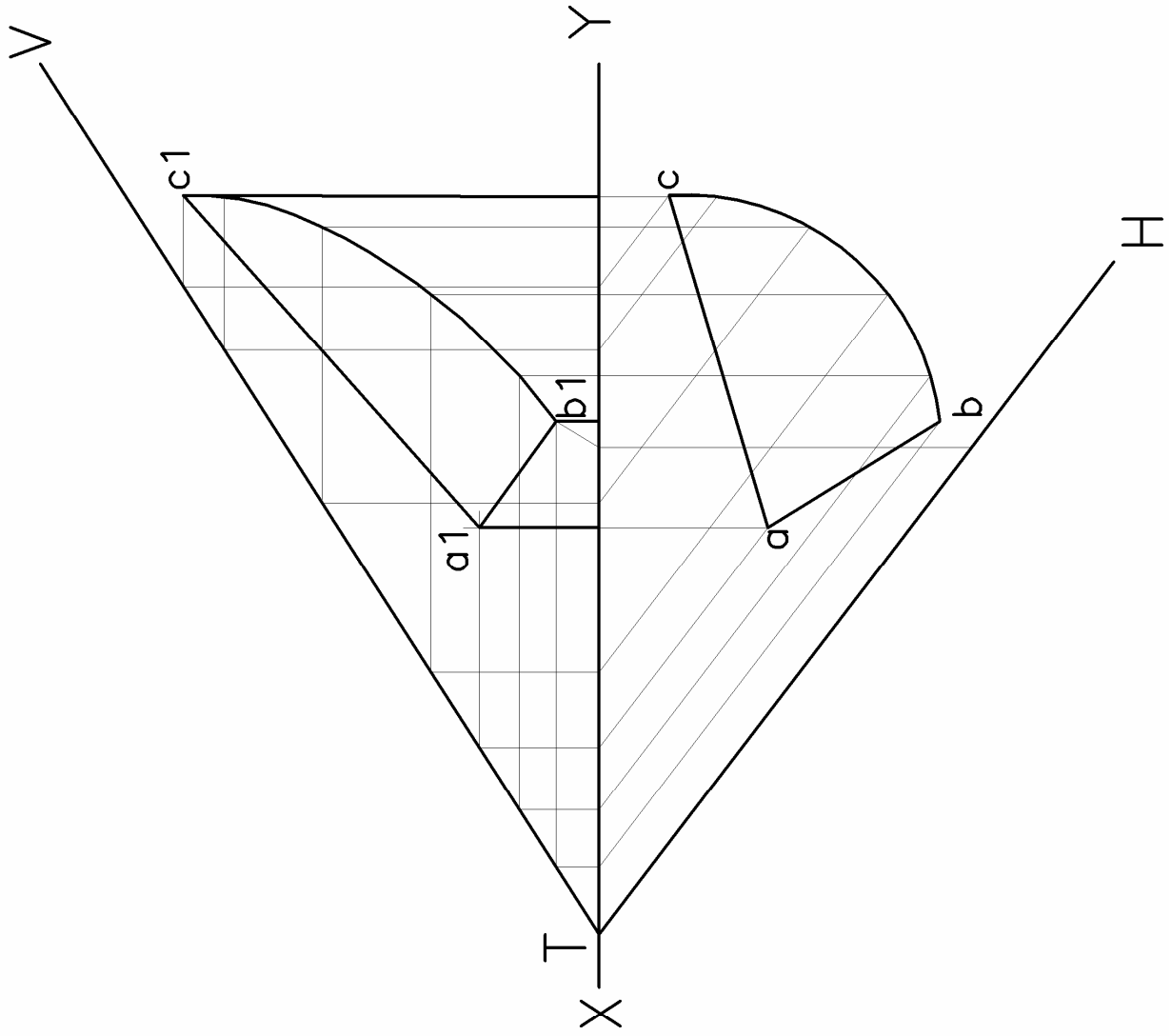

Question 6

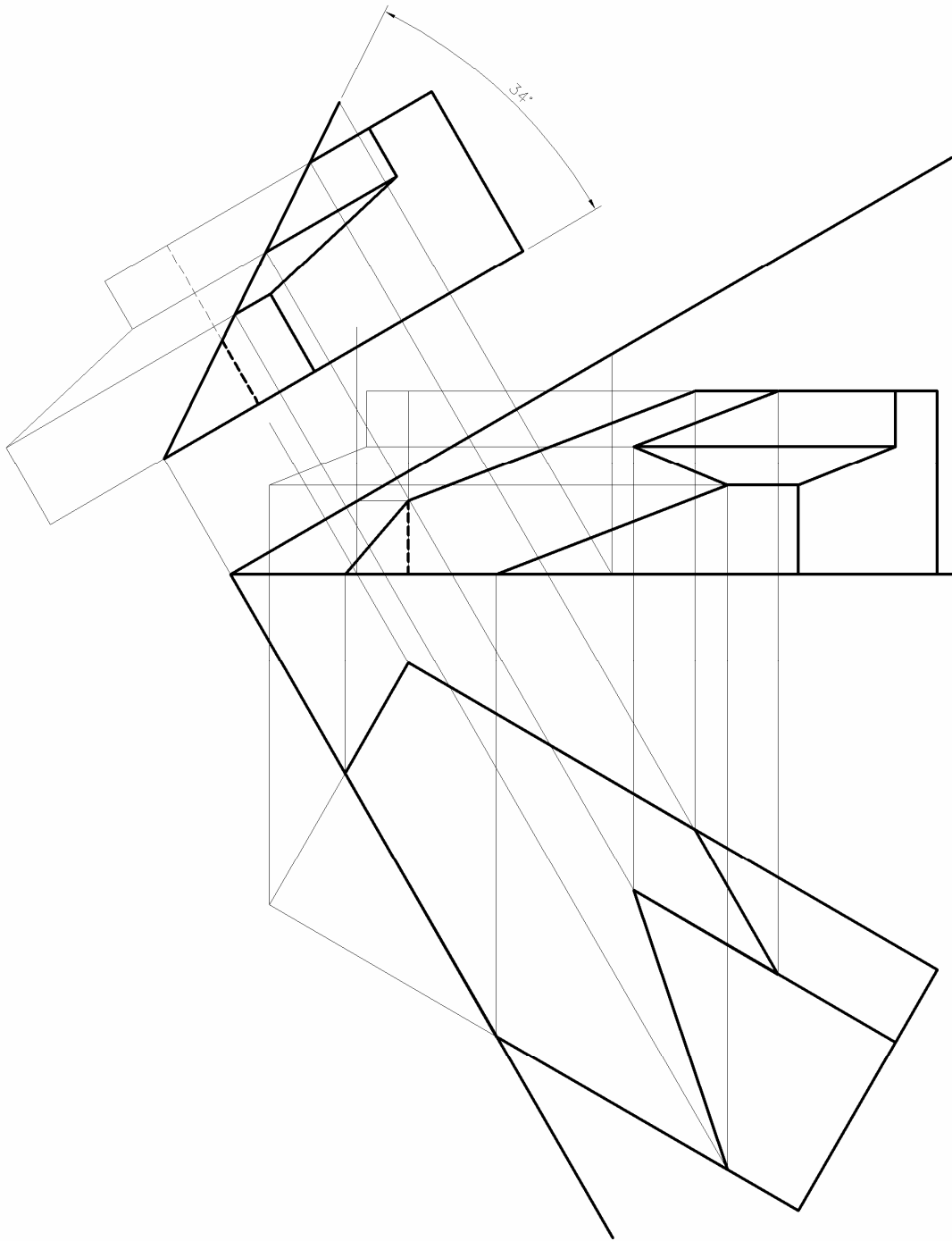

Question 7

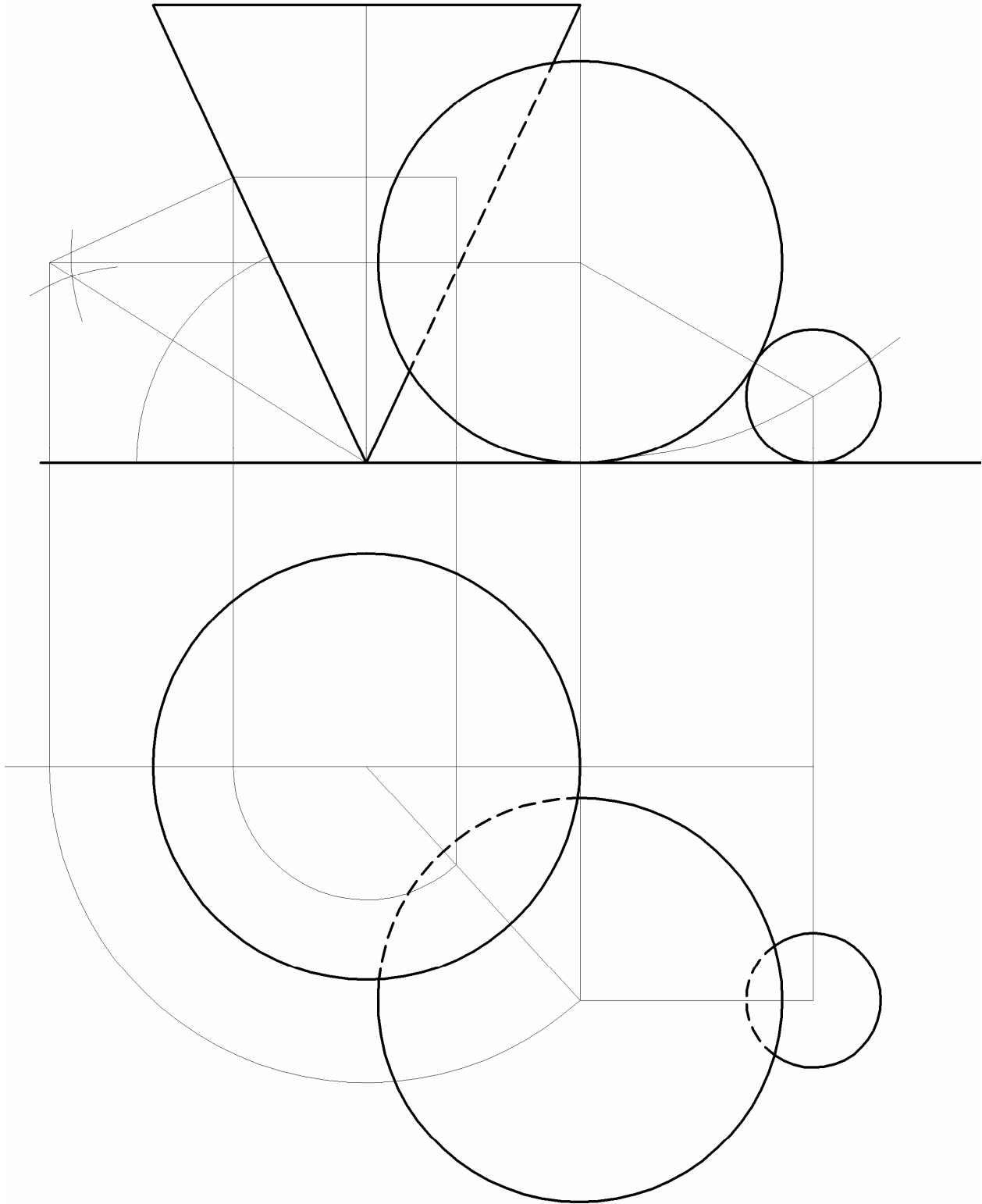

Question 8

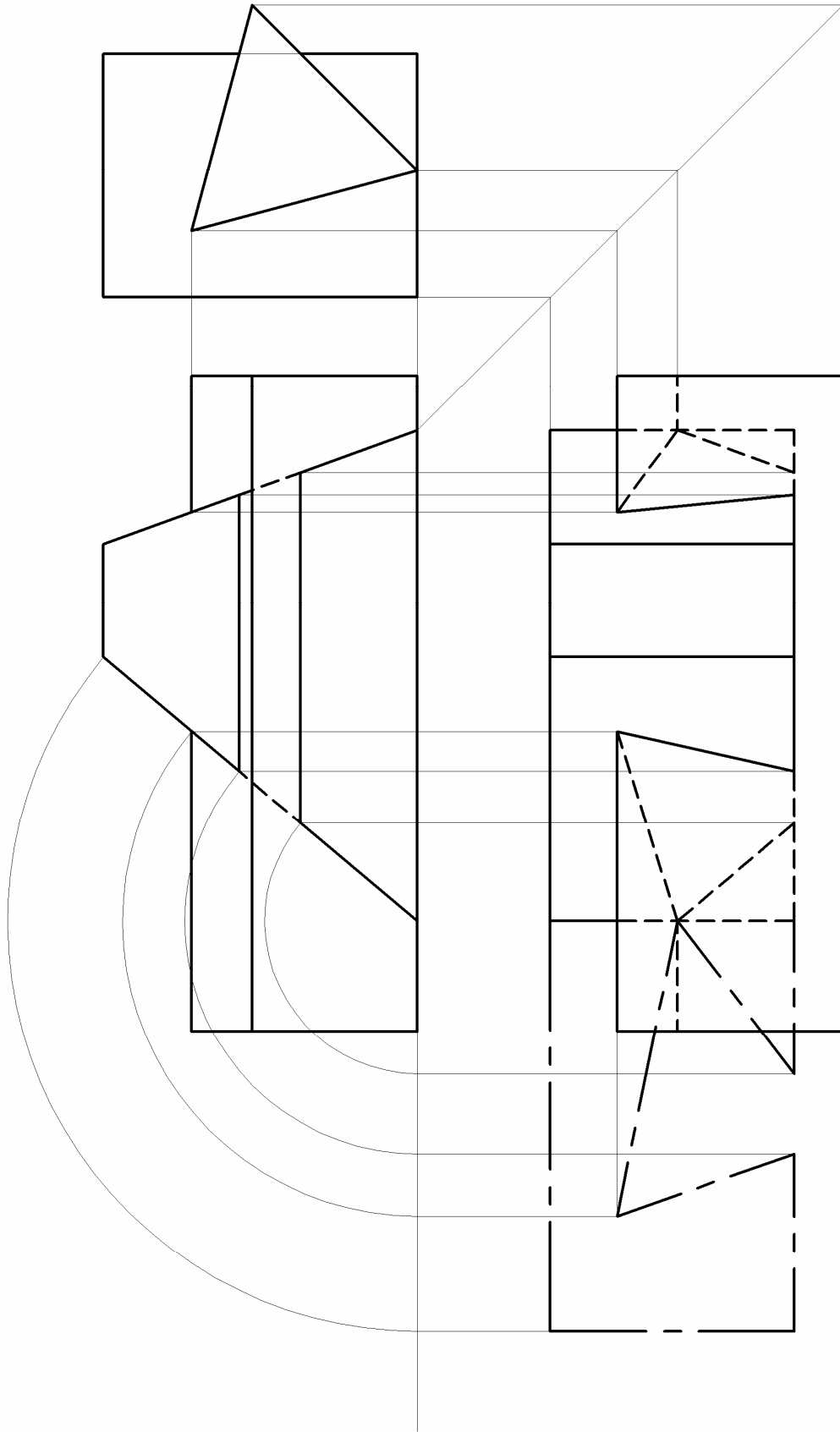

Qusetion 9

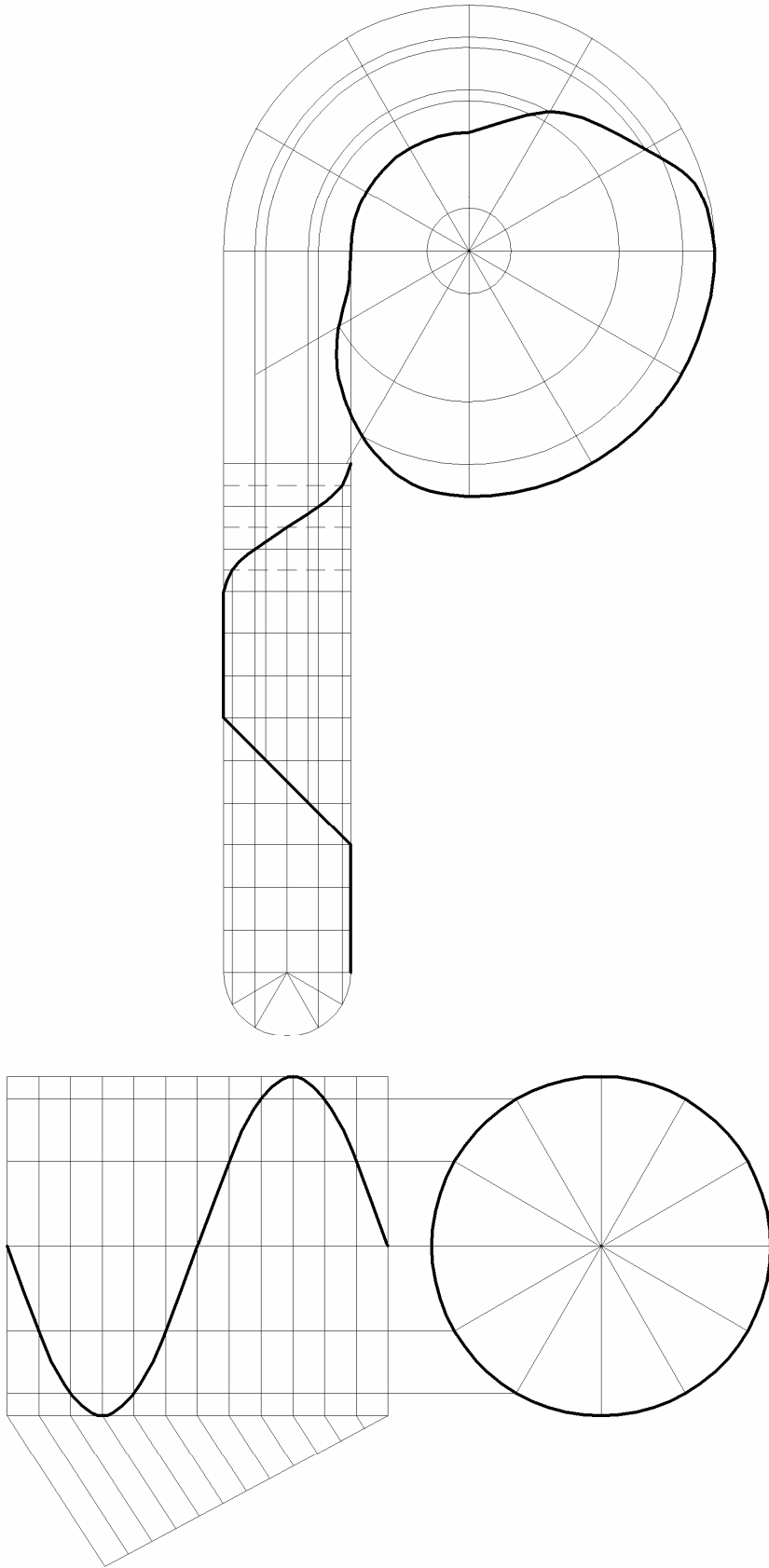

Question 10

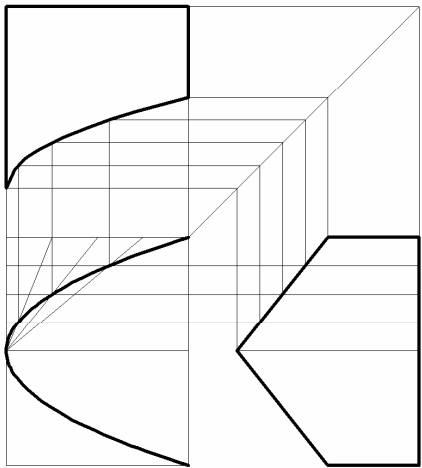
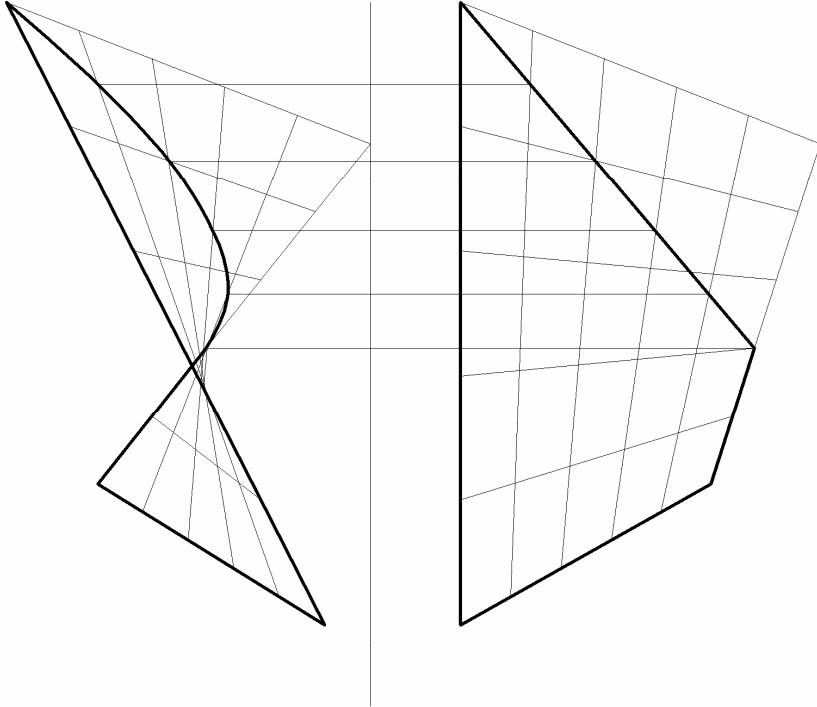

Question 11

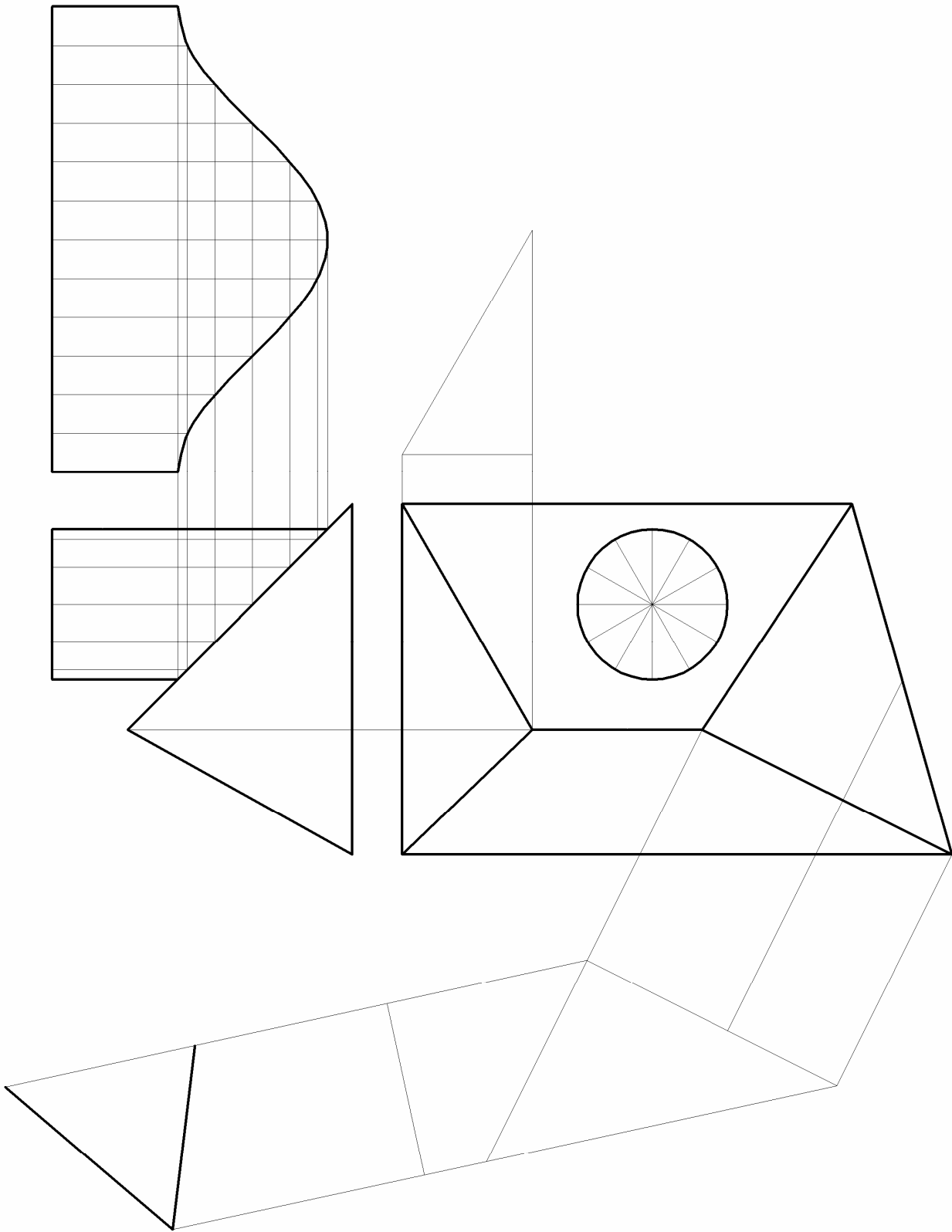

Question 12

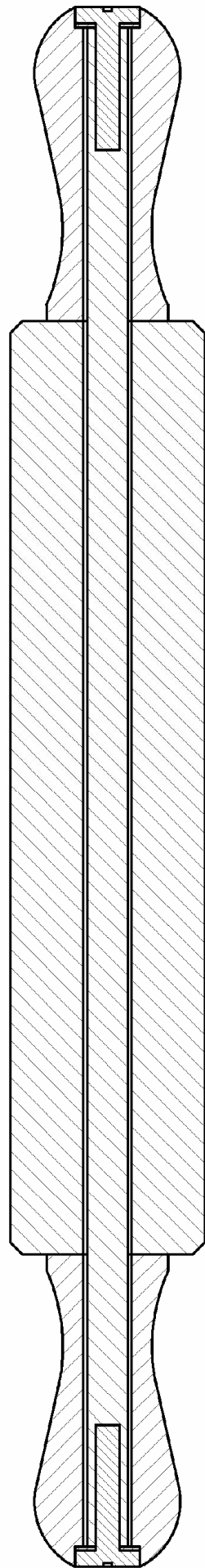

SECTION A-A



Question 13

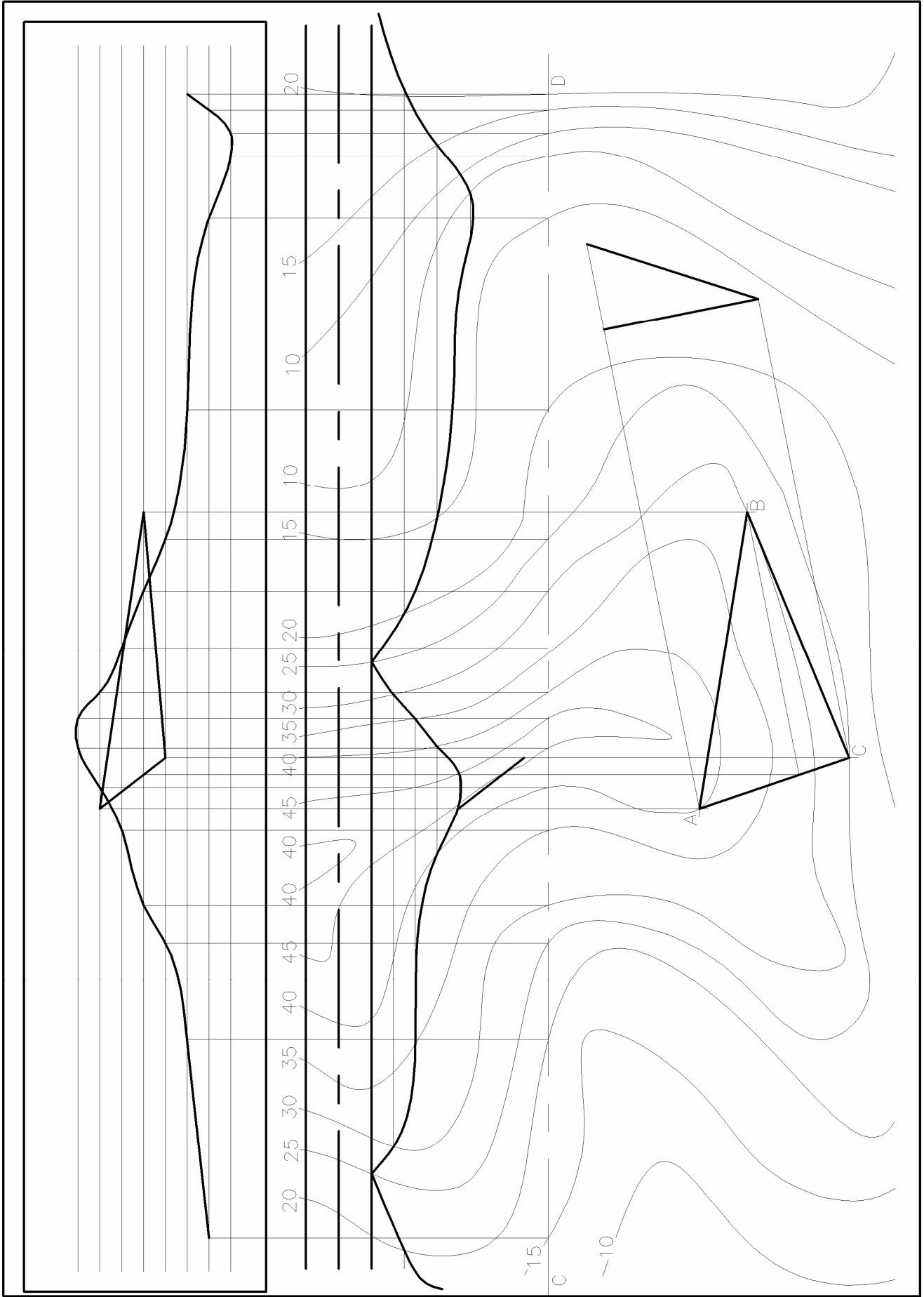

Handwritten notes on a grid background.