

The drawing below shows the incomplete elevation and plan of a building. It is composed of a number of solids which intersect each other.

- (a) Project an end view of the building.
- (b) Complete the elevation and plan of the building showing all lines of interpenetration.
- (c) Determine the dihedral angle between the surfaces A and B.

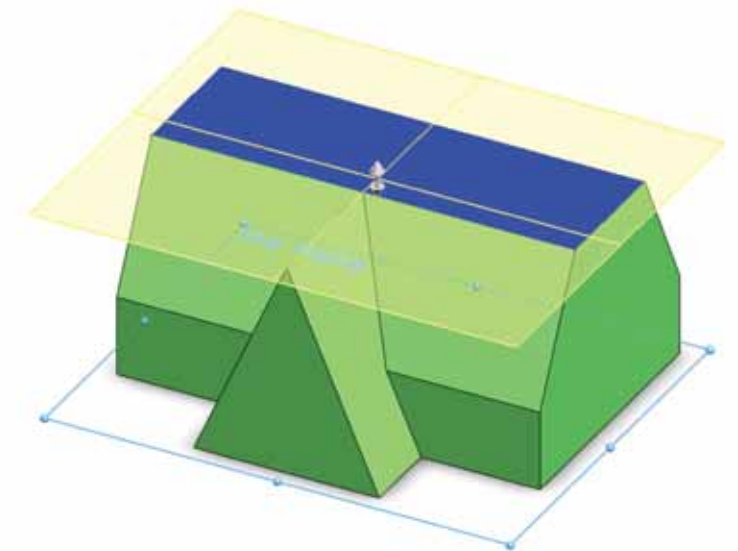
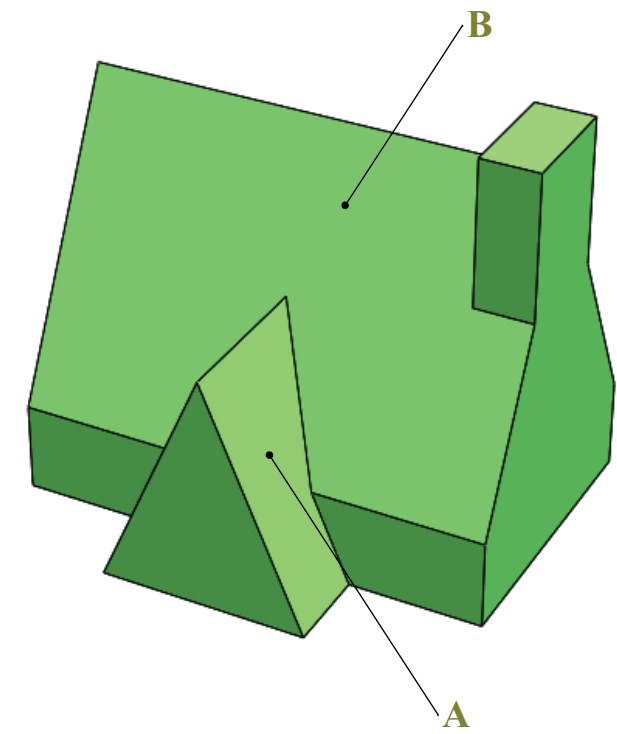
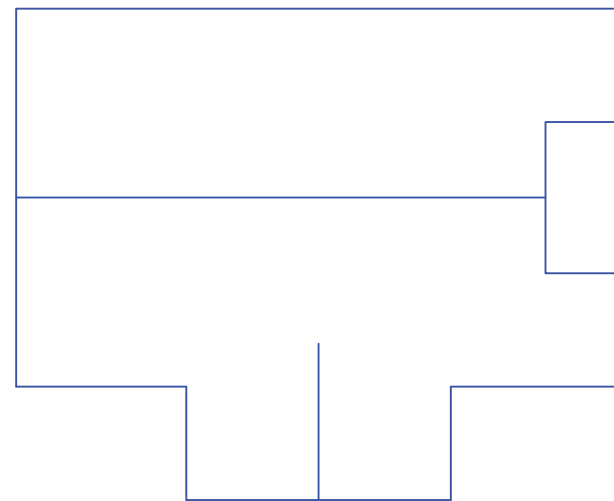
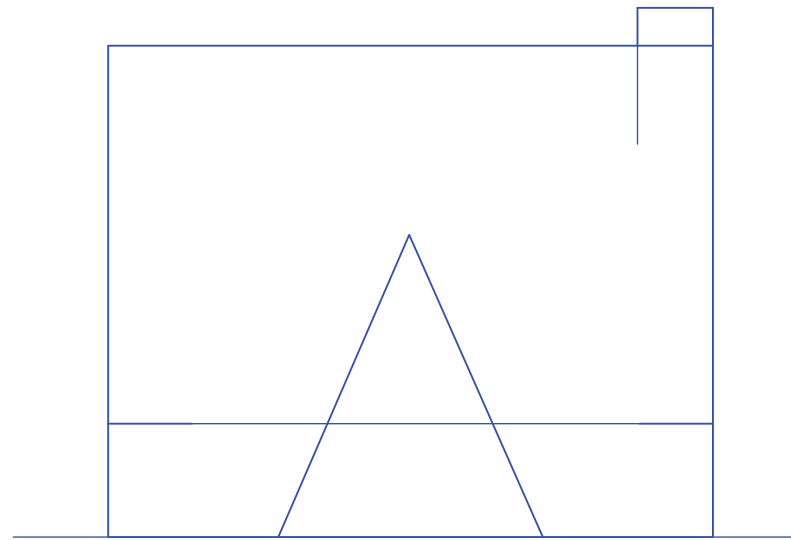
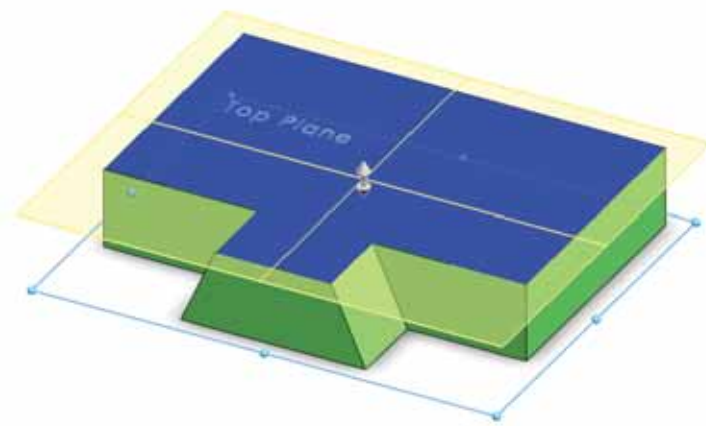

Shown are the elevation, plan and pictorial views of a corner post intersected by a horizontal rail and a simply inclined strut.

The corner post is in the shape of a hexagonal based prism and the rail and strut are rectangular in section.

Complete the elevation by including all lines of interpenetration.

Draw a complete surface development of the inclined strut.

Determine the dihedral angle between surfaces A and B.

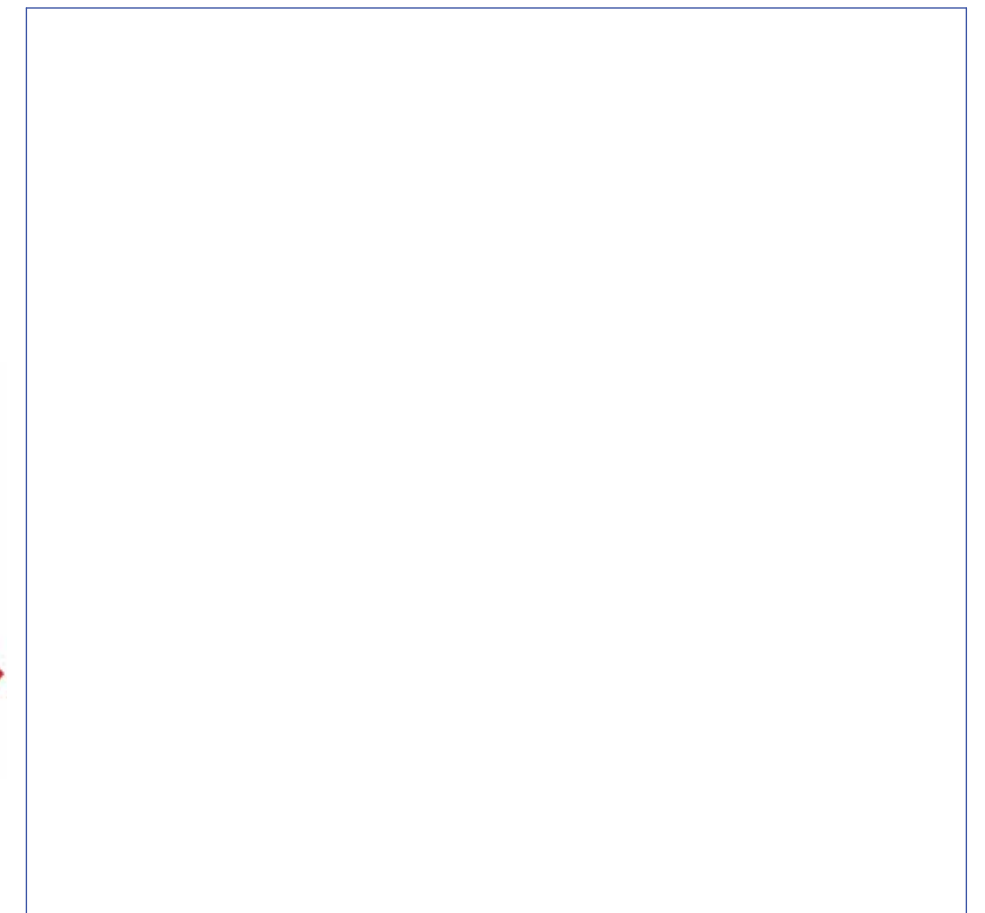
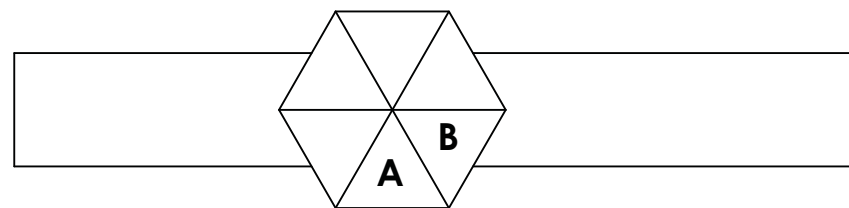
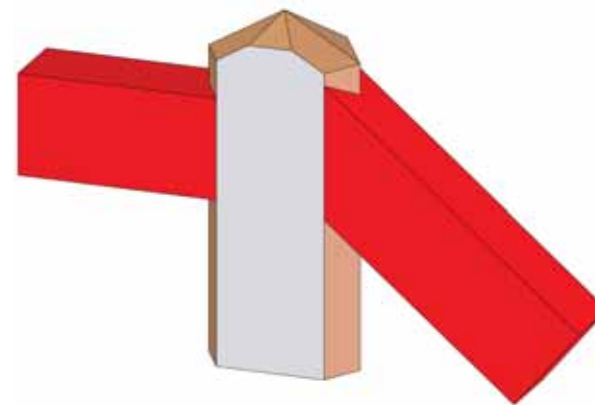
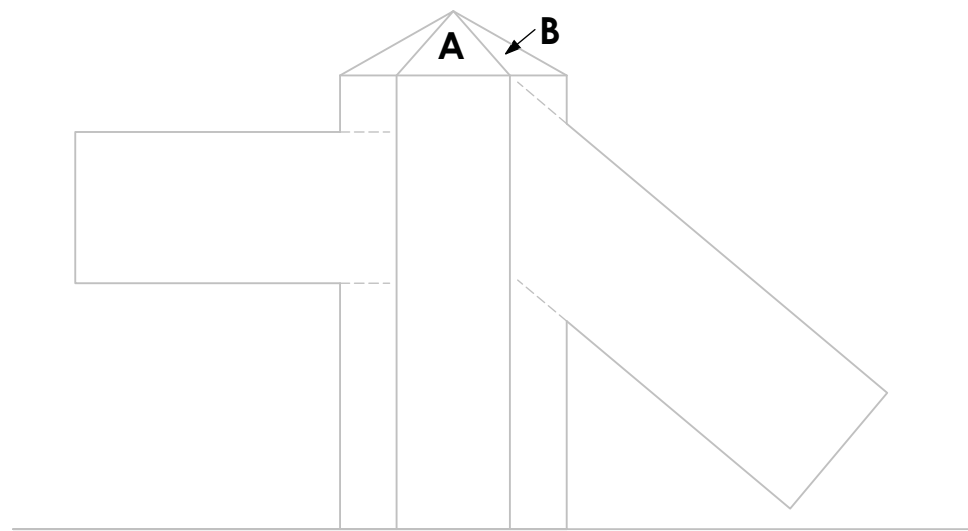
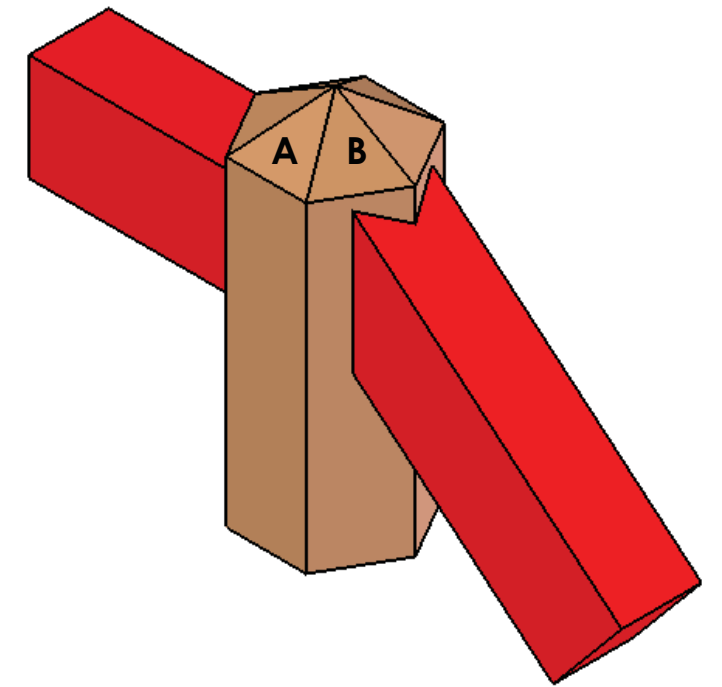

Make a neat freehand sketch of how the horizontal rail joins to the corner post.

Suggest a method of enhancing the appearance of the horizontal rail.



TECHNOLOGY SUBJECTS SUPPORT SERVICE DESIGN & COMMUNICATION GRAPHICS Intersection & Development of Surfaces

NAME: \_\_\_\_\_ DATE: \_\_\_\_\_



In recent years, outdoor decks have become a common home improvement addition for many homeowners. A 3D graphic of a deck construction is shown on the left.

They are built with pressure treated lumber so that they will last for years. To add the finishing touches to the structure, the posts of the deck rails may be covered with a metal fence post cap like the one shown in the graphic on the right.



A model of a cap for a post which is to be made from sheet aluminium is also shown below. The drawing below shows the projections of a pyramid post cap.

- (a) Draw a complete surface development of the cap keeping the number of joints to a minimum.
- (b) Determine the size of the smallest rectangular piece of aluminium from which the aluminium cap can be made.

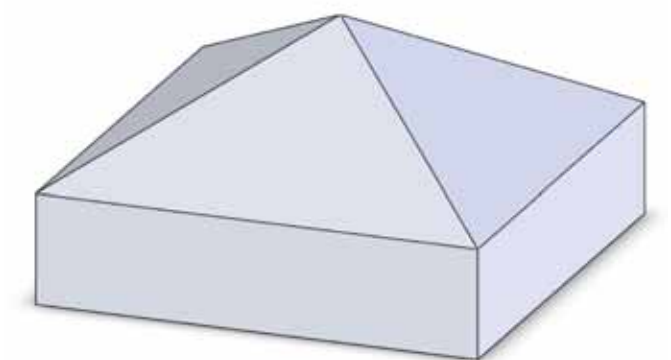
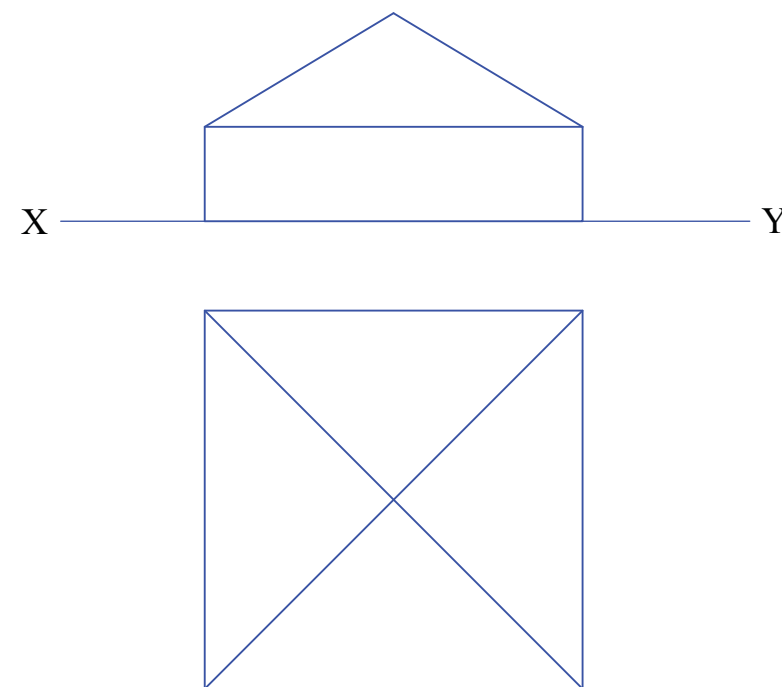
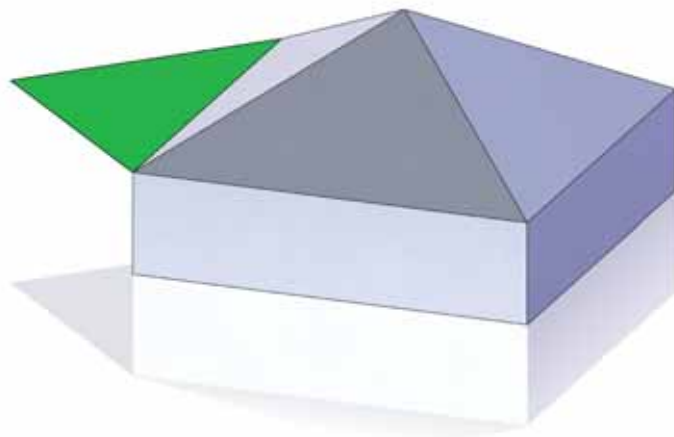

NAME: \_\_\_\_\_ DATE: \_\_\_\_\_

Shown is a cardboard model for a box for an easter egg based on a pentagonal prism with a square hole cut through it.

Also shown are the plan and elevation of the box.

Project the end view.

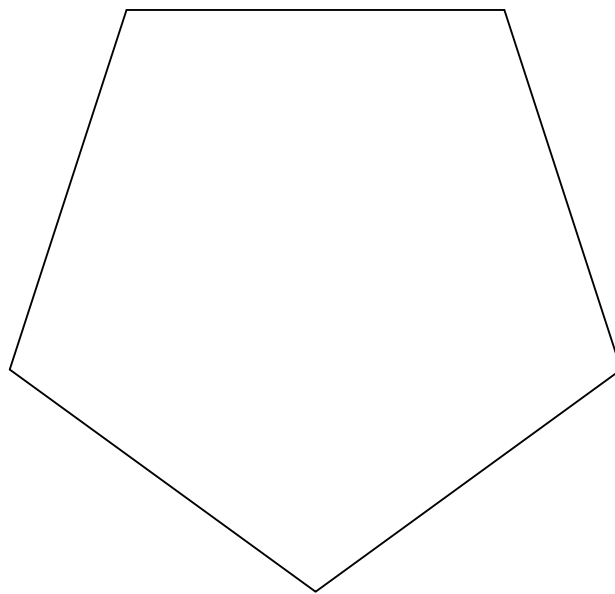
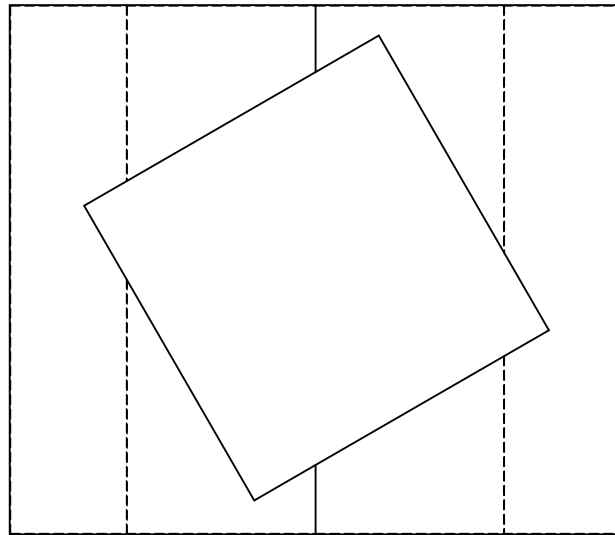
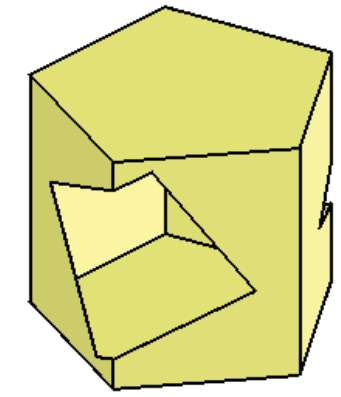

The drawing below shows the incomplete elevation, plan and end elevation of a building and its entrance. A pictorial view of the structure is also shown across.

The entrance hall is in the shape of a triangular prism.

- (a) Complete the given views showing all lines of interpenetration between the hall and the building.
- (b) Draw the complete surface development of the entrance hall.

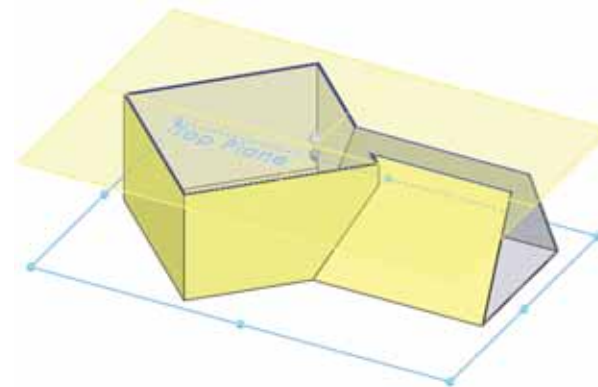
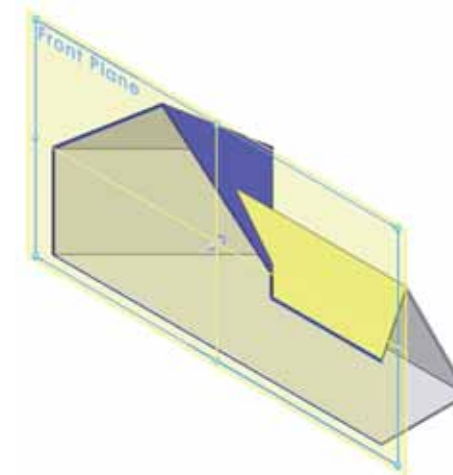
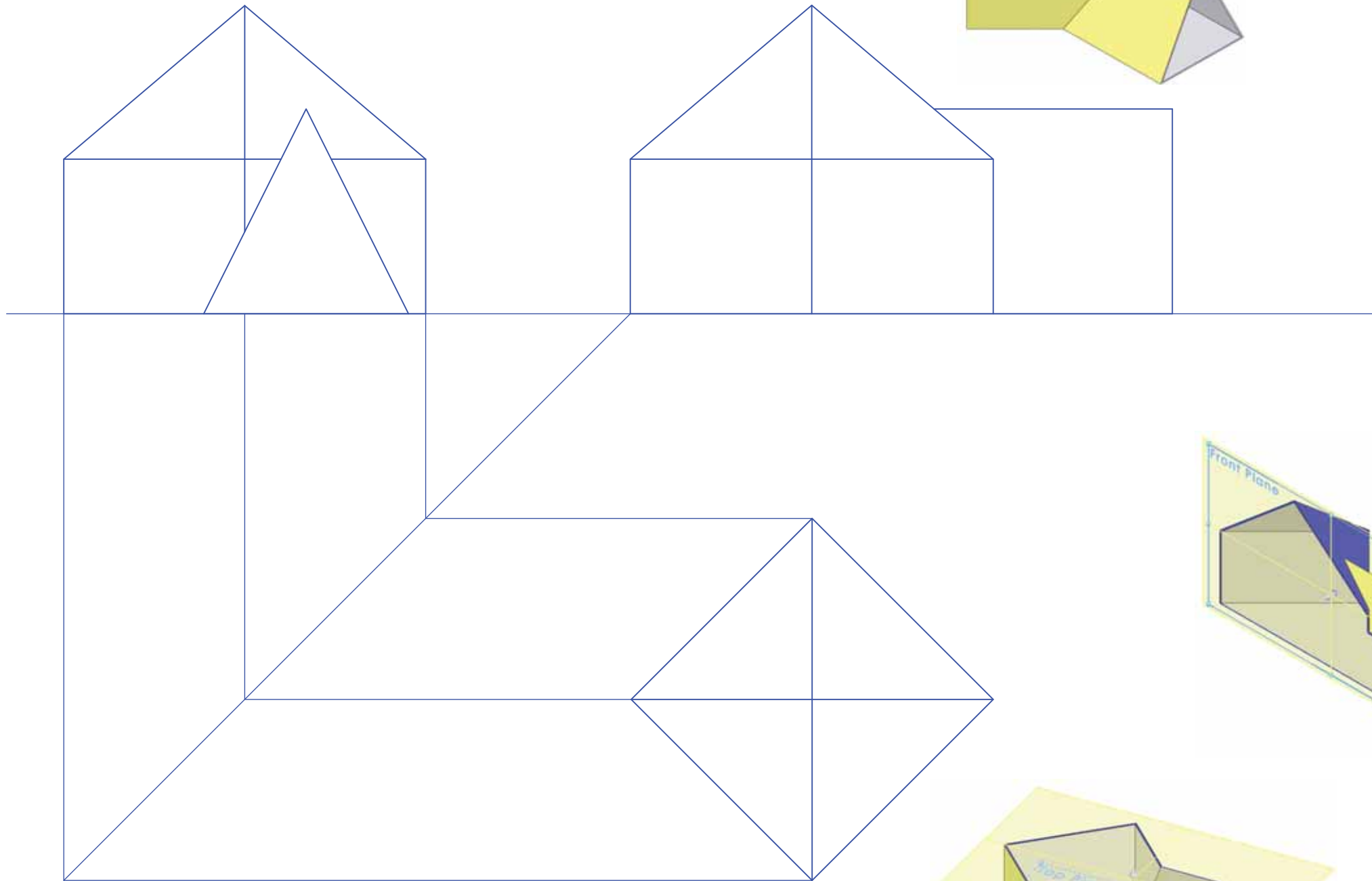
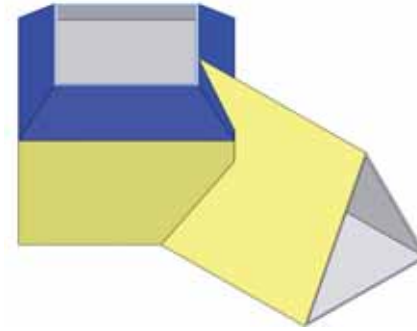
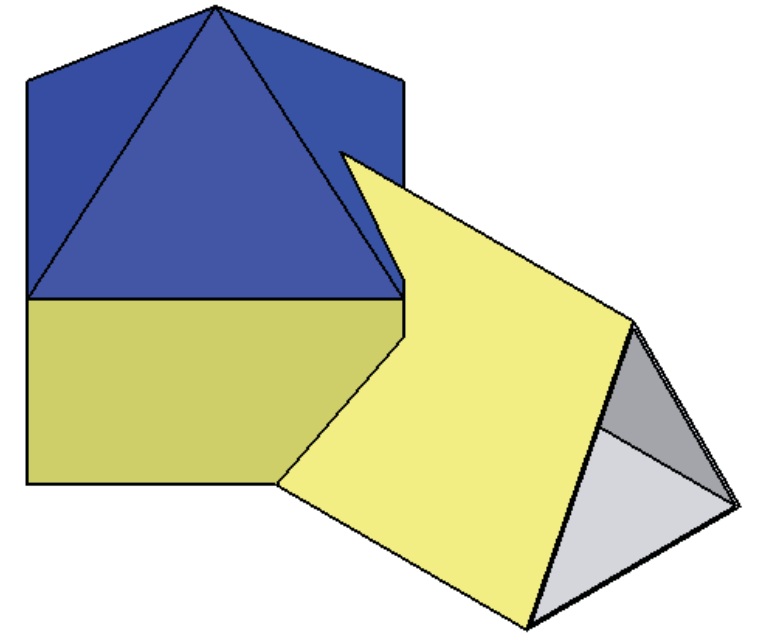



The 3D graphic on the right shows an extractor fan hood. It is composed of a right circular cone which has been shaped as shown (see below right) and a right cylinder which intersect each other.

The drawing below shows the plan and incomplete elevation and end view of the extractor fan hood.

- (a) Complete the elevation and end view.
- (b) Draw the complete surface development of the cylindrical portion of the object.  
(The top and surface may be excluded).

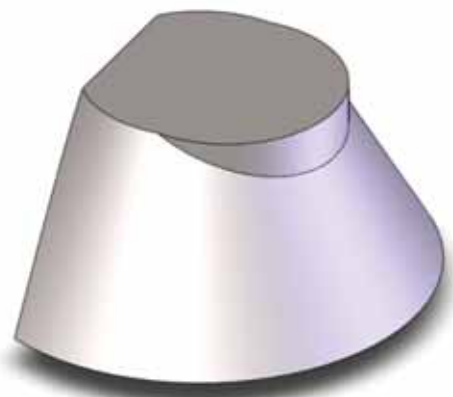
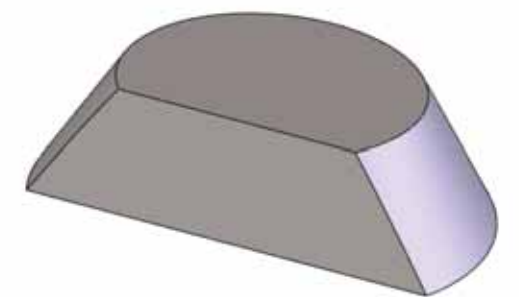
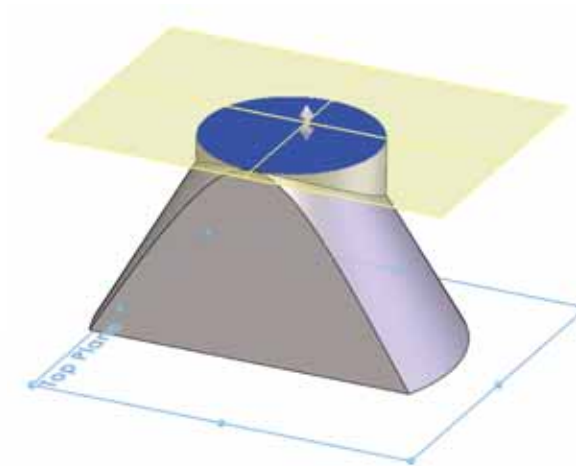
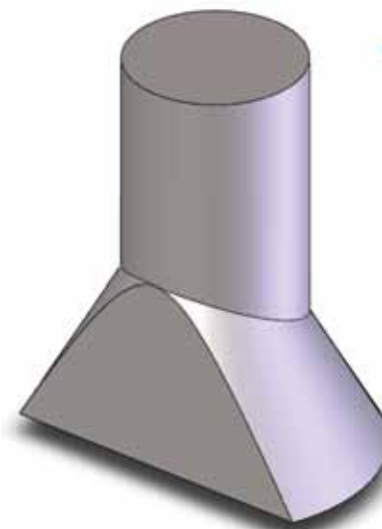
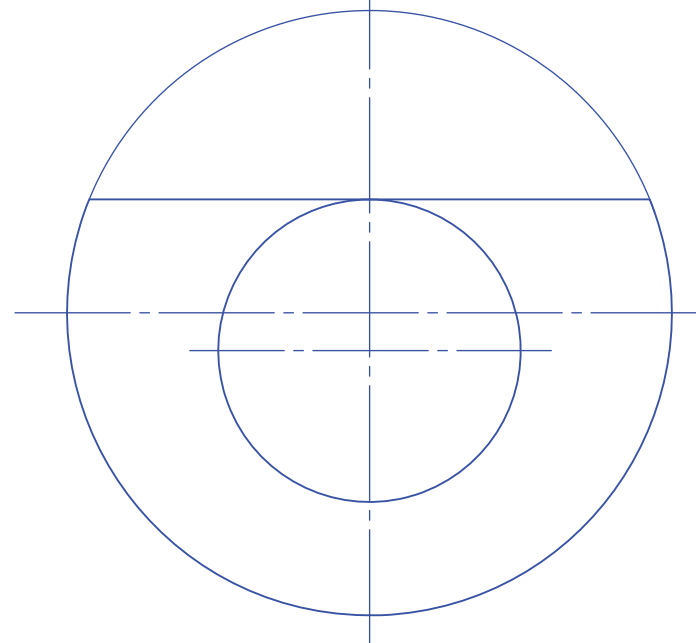
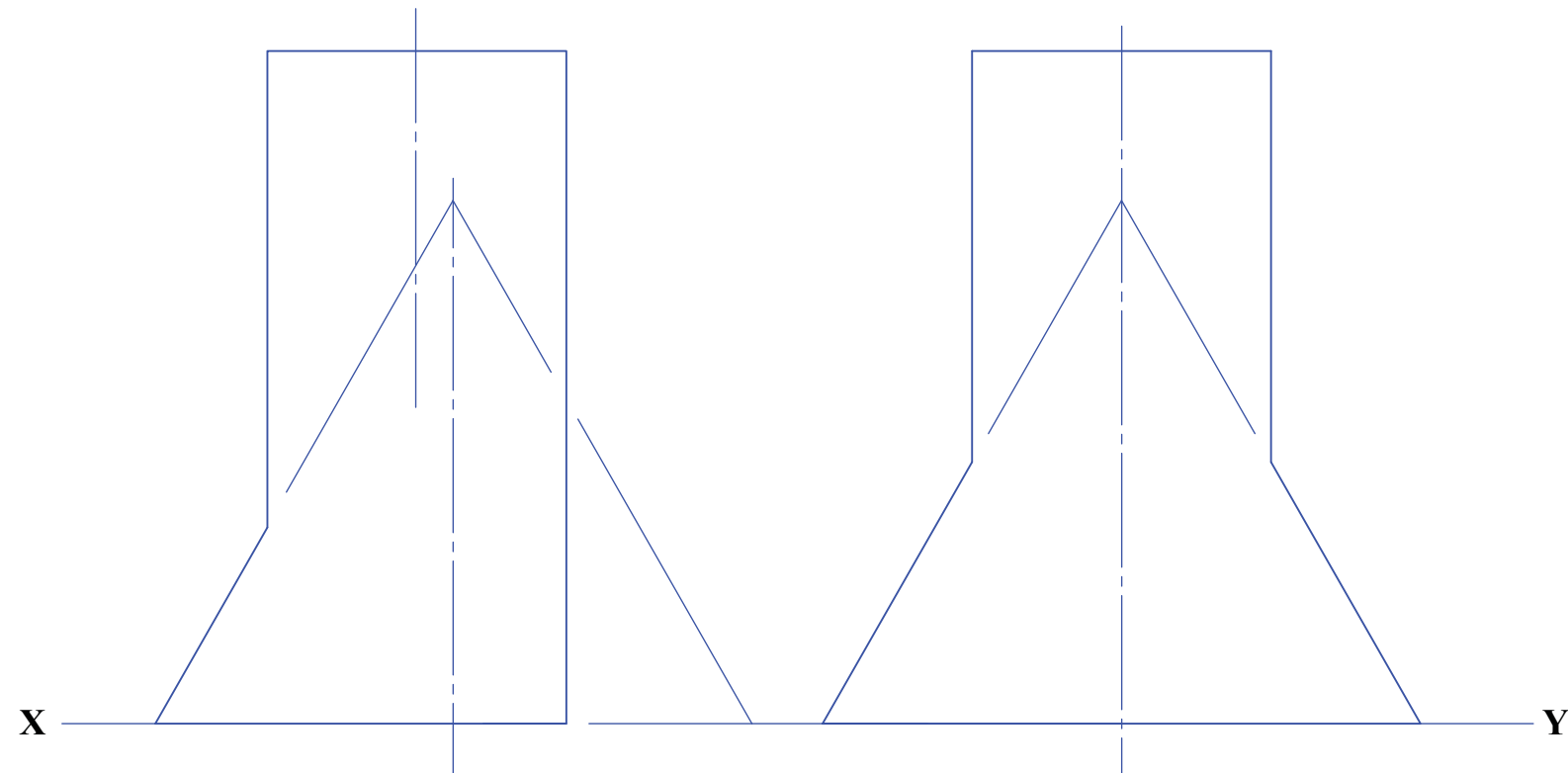
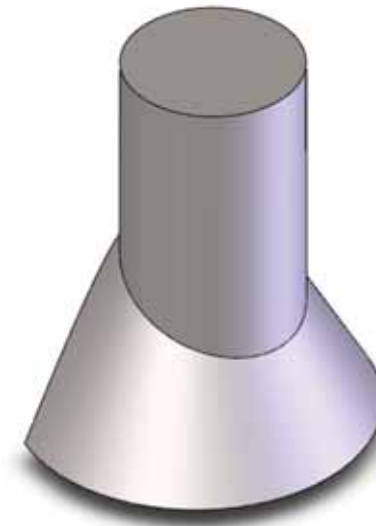

TECHNOLOGY  
SUBJECTS  
SUPPORT  
SERVICE

DESIGN & COMMUNICATION GRAPHICS

Intersection & Development of Surfaces

NAME: \_\_\_\_\_ DATE: \_\_\_\_\_



The 3D graphic on the left shows some easter egg boxes based on hexagonal prisms. The openings are rectangular in shape.

A 3D graphic of a hexagonal prism which contains an irregular-shaped opening is shown on the right. The drawing below shows the plan and elevation of the hexagonal prism. The development of the transparent opening for the prism is also shown in the elevation.

- (a) Complete the elevation to show the opening in position.
- (b) Draw the complete surface development of the prism to include the opening.  
(The top and bottom surfaces may be excluded).

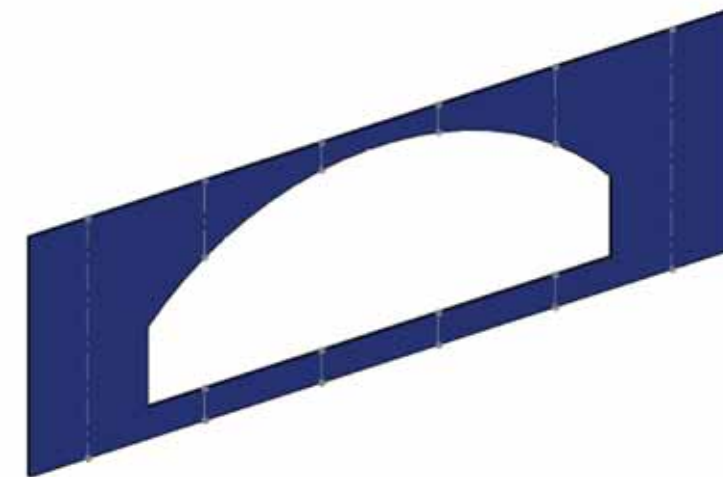
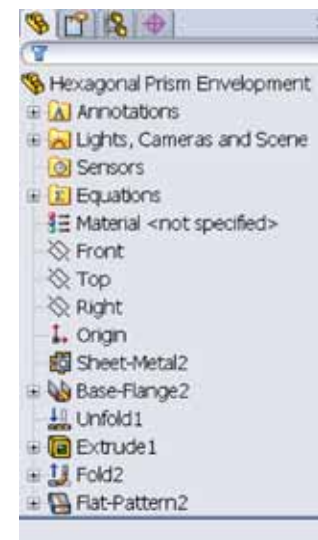
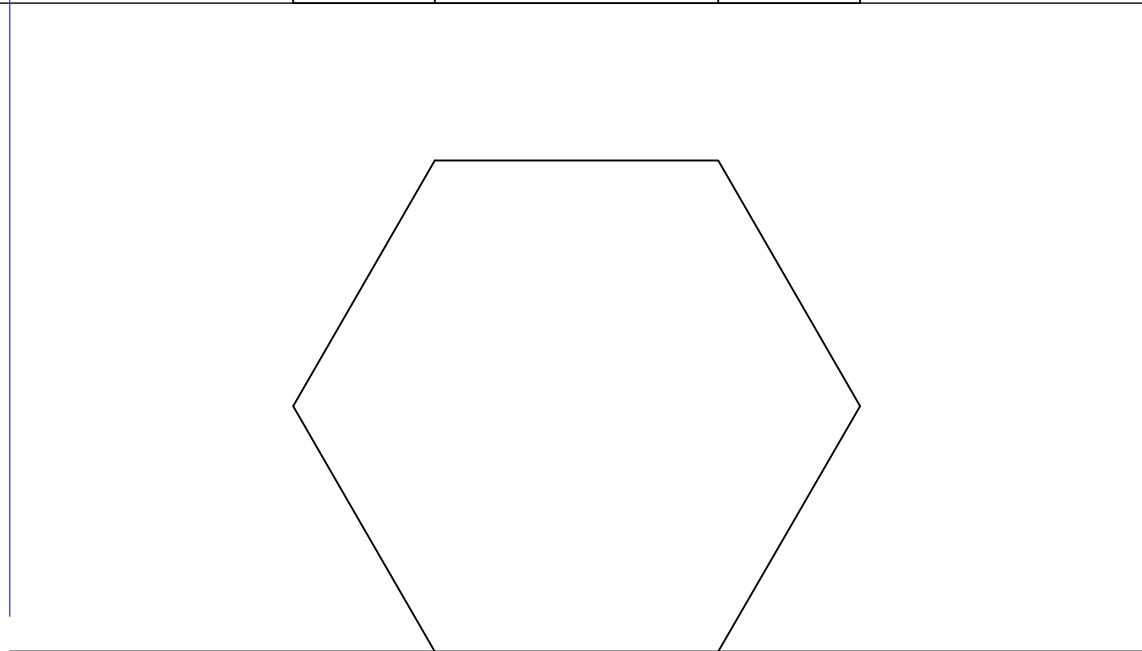
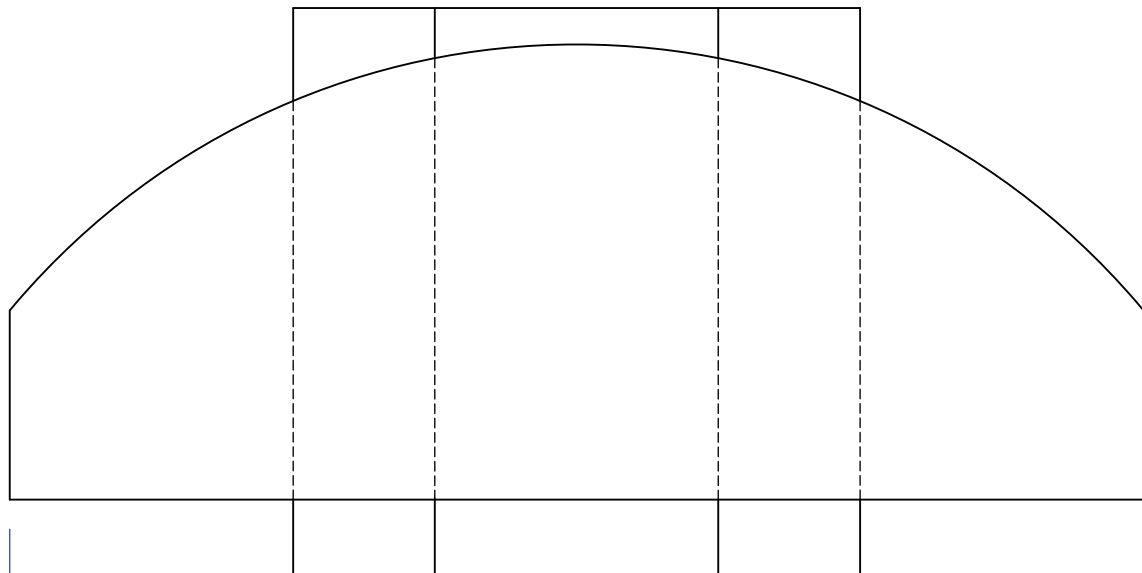
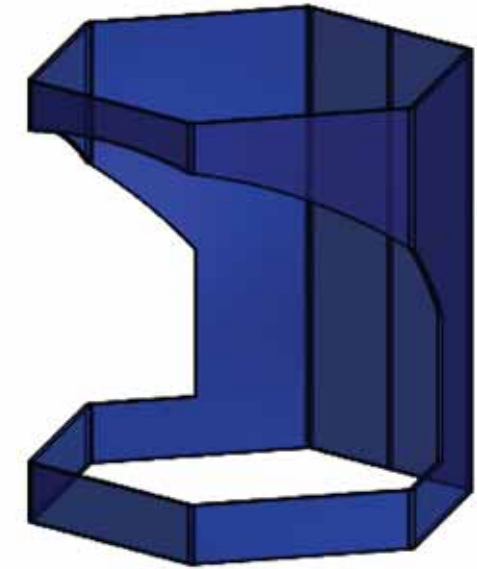

Shown are the incomplete elevation, plan and end elevation for a house.

It includes a dormer window which has a roof surface in the shape of a semi-cylinder.

Complete the given views to include all lines of intersection.

Develop the curved surface of the dormer roof.

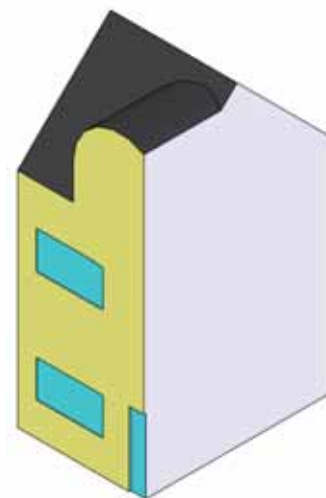
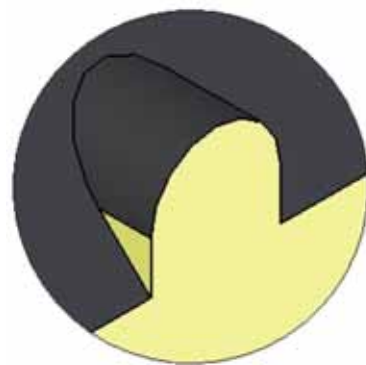
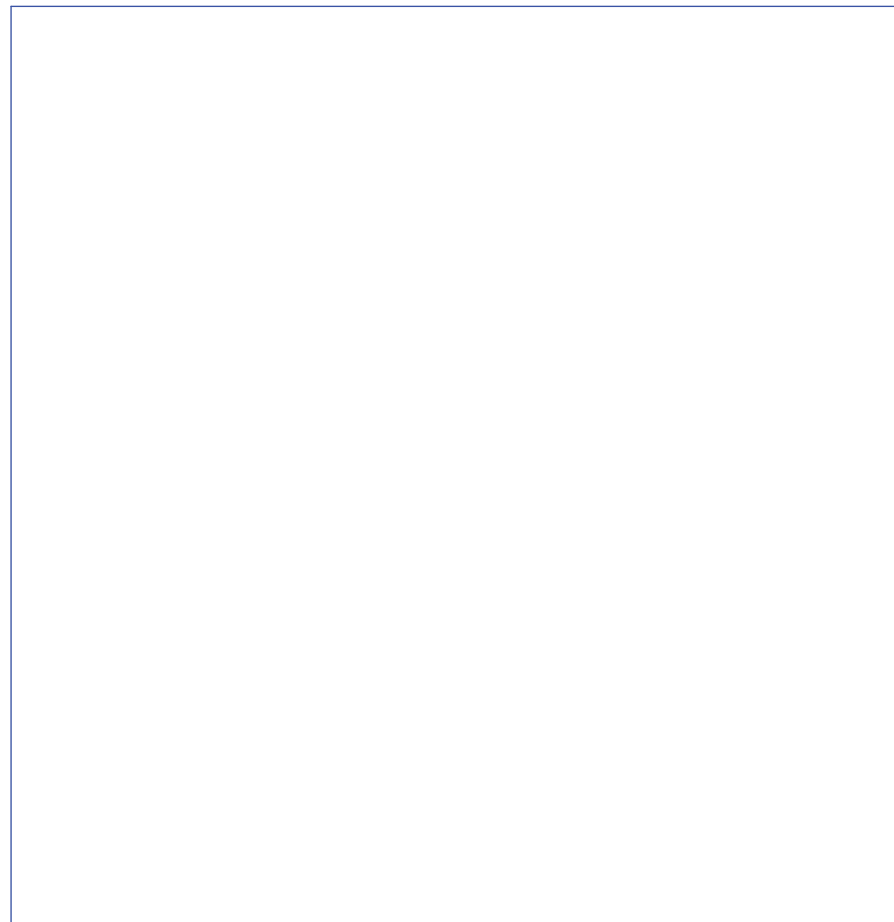
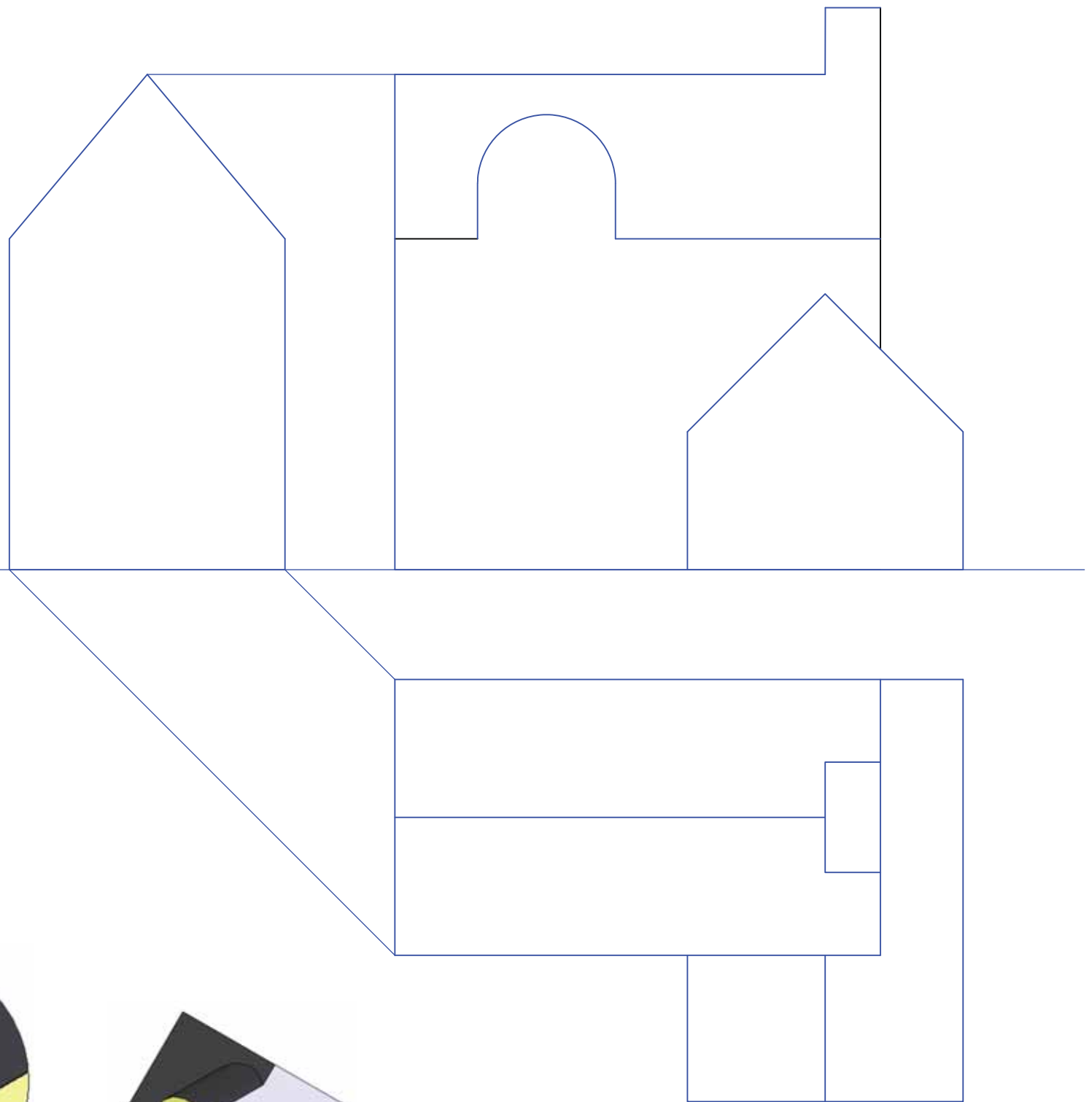
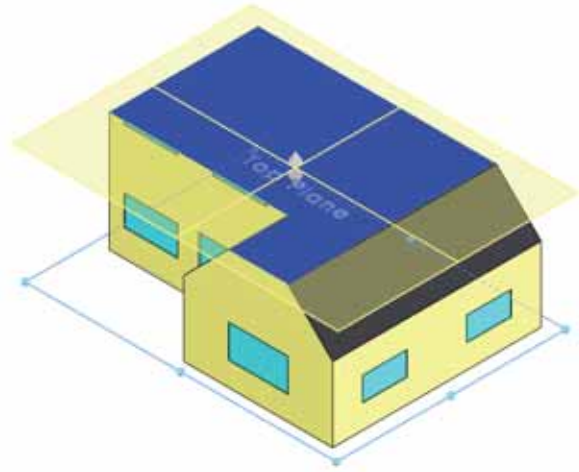
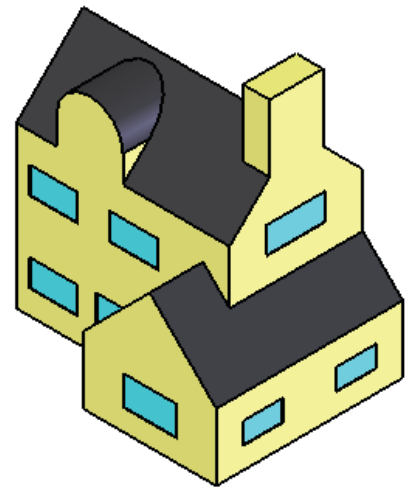

Make a neat, freehand isometric sketch of an upright cylinder that has been cut by a simply inclined plane. Illustrate on the sketch how straight line elements on the surface of the cylinder may be located.



**DESIGN & COMMUNICATION GRAPHICS**

**Intersection & Development of Surfaces**

NAME: \_\_\_\_\_ DATE: \_\_\_\_\_



A model of a cardboard box file for storing magazines is shown.

- (a) Make a complete one piece development of the box.
- (b) A logo in the shape of an equilateral triangle of side 70mm is to be placed centrally on the high end of the box as shown. Determine how much of the label will be visible in elevation.

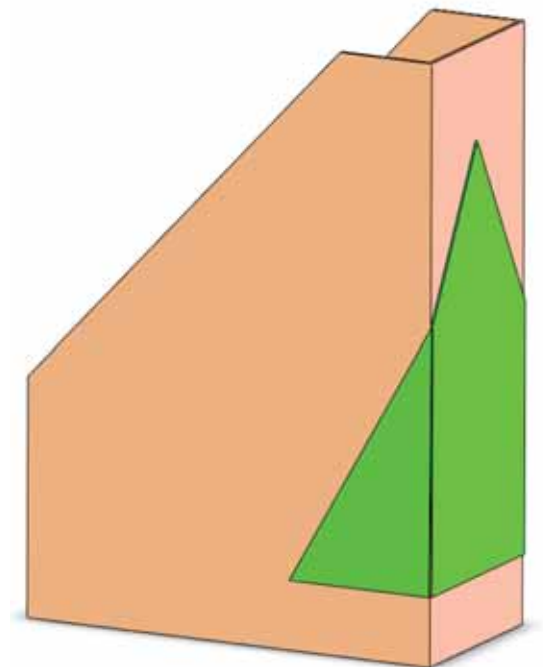
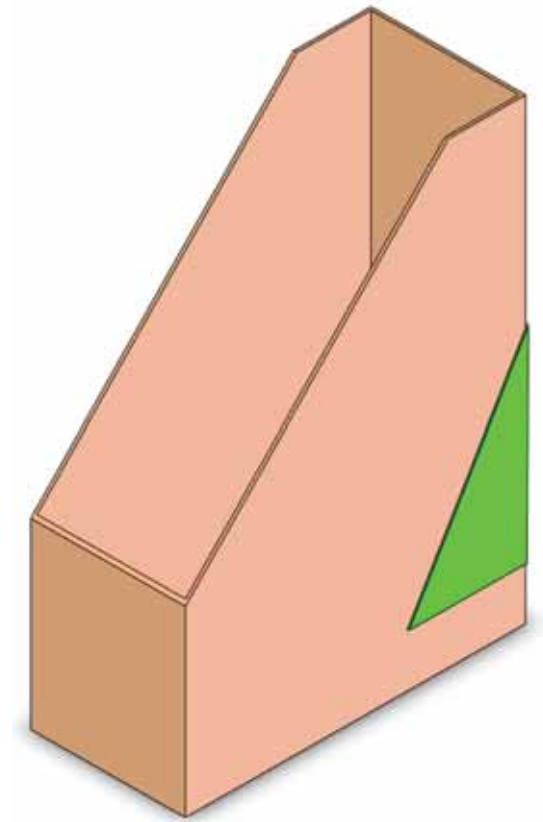
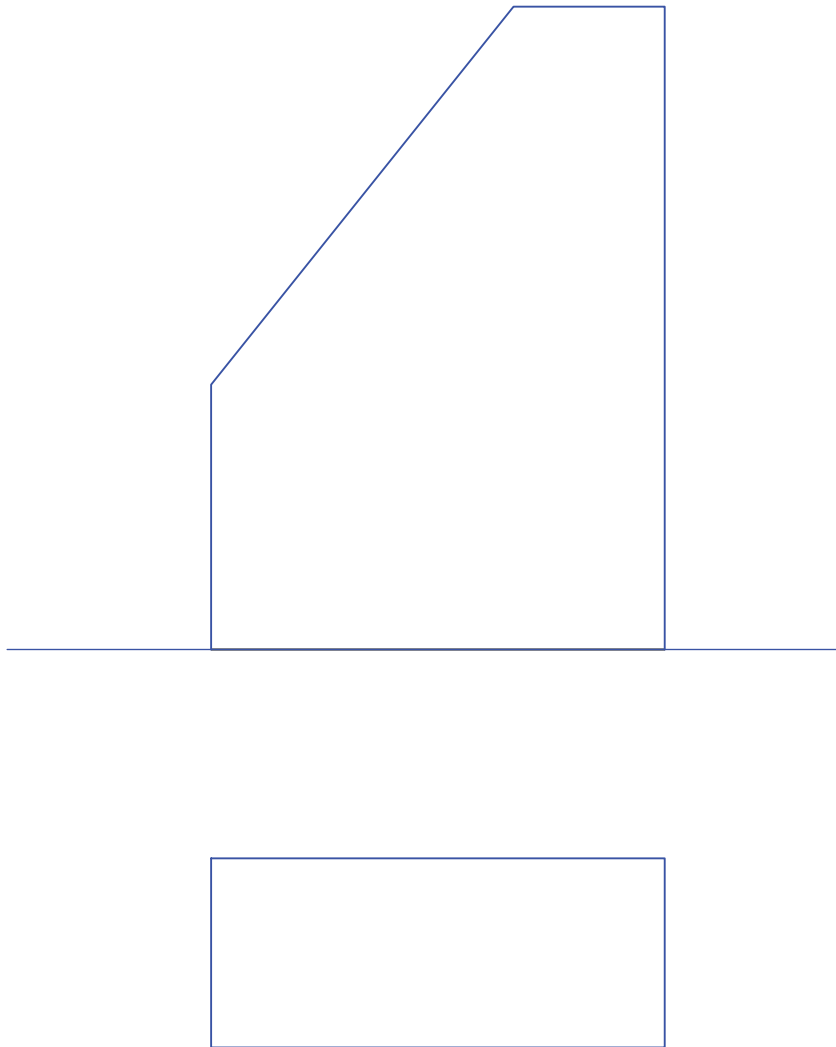

Shown is the incomplete elevation and plan of a stone monument.

It consists of a truncated Limestone pentagonal based prism intersected by an inclined square based prism made from Granite.

Also shown is a model of the monument.

Complete the elevation and plan by locating all lines of intersection between the solids.

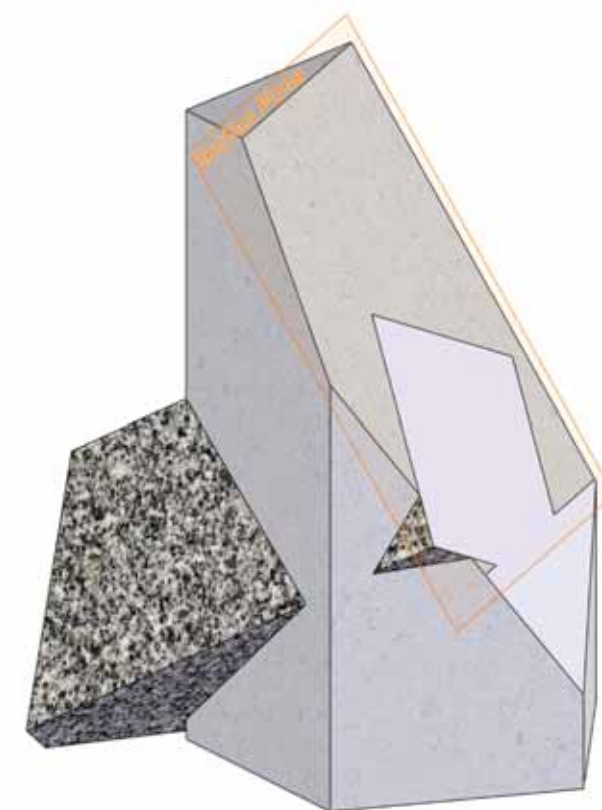
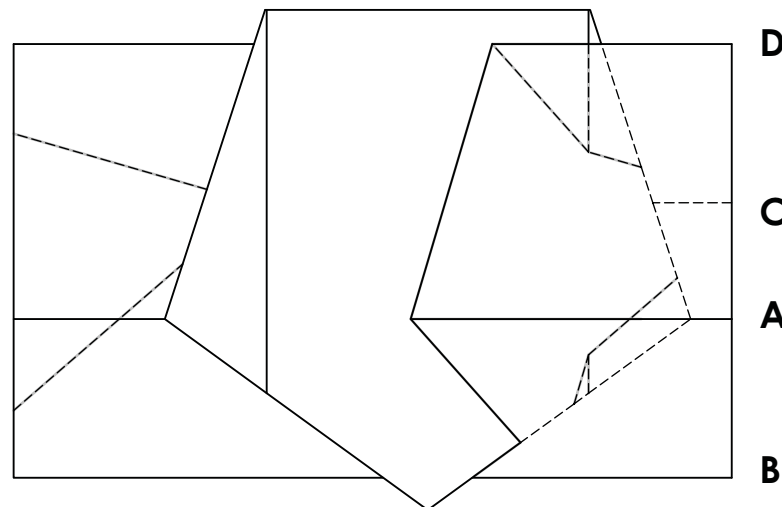
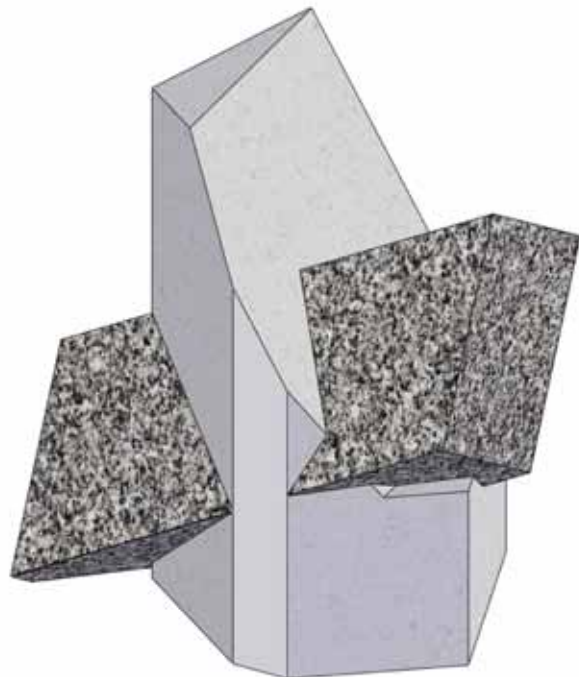
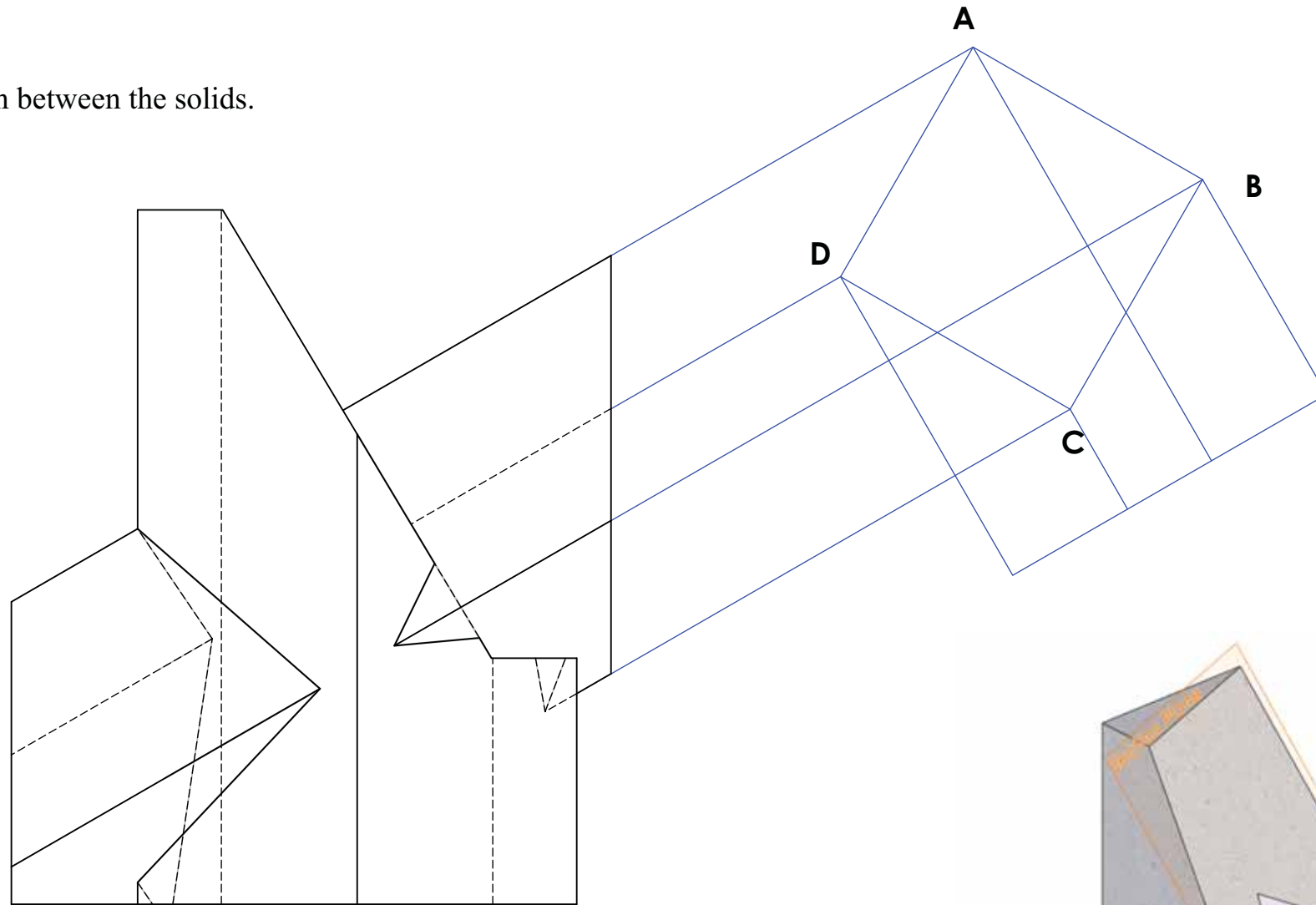
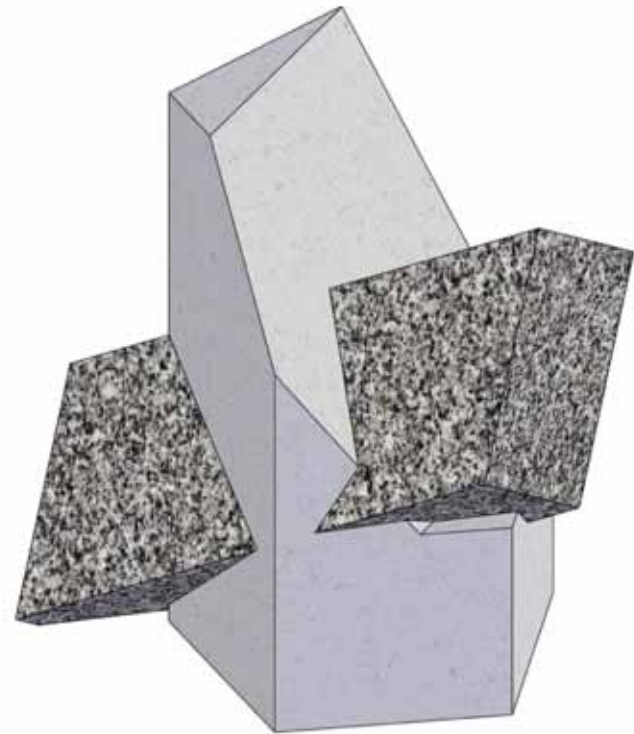

Shown is the incomplete elevation and plan of a stone monument.

It consists of a truncated Limestone pentagonal based prism intersected by an inclined square based prism made from Granite.

Also shown is a model of the monument.

Complete the elevation and plan by locating all lines of intersection between the solids.

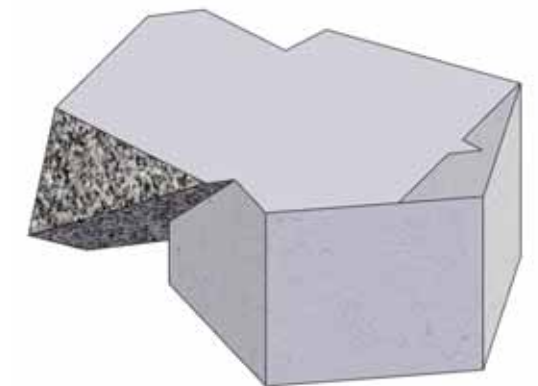
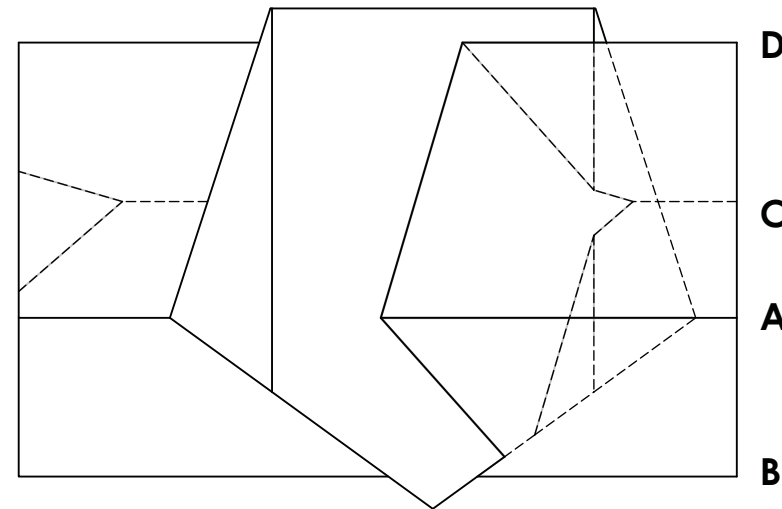
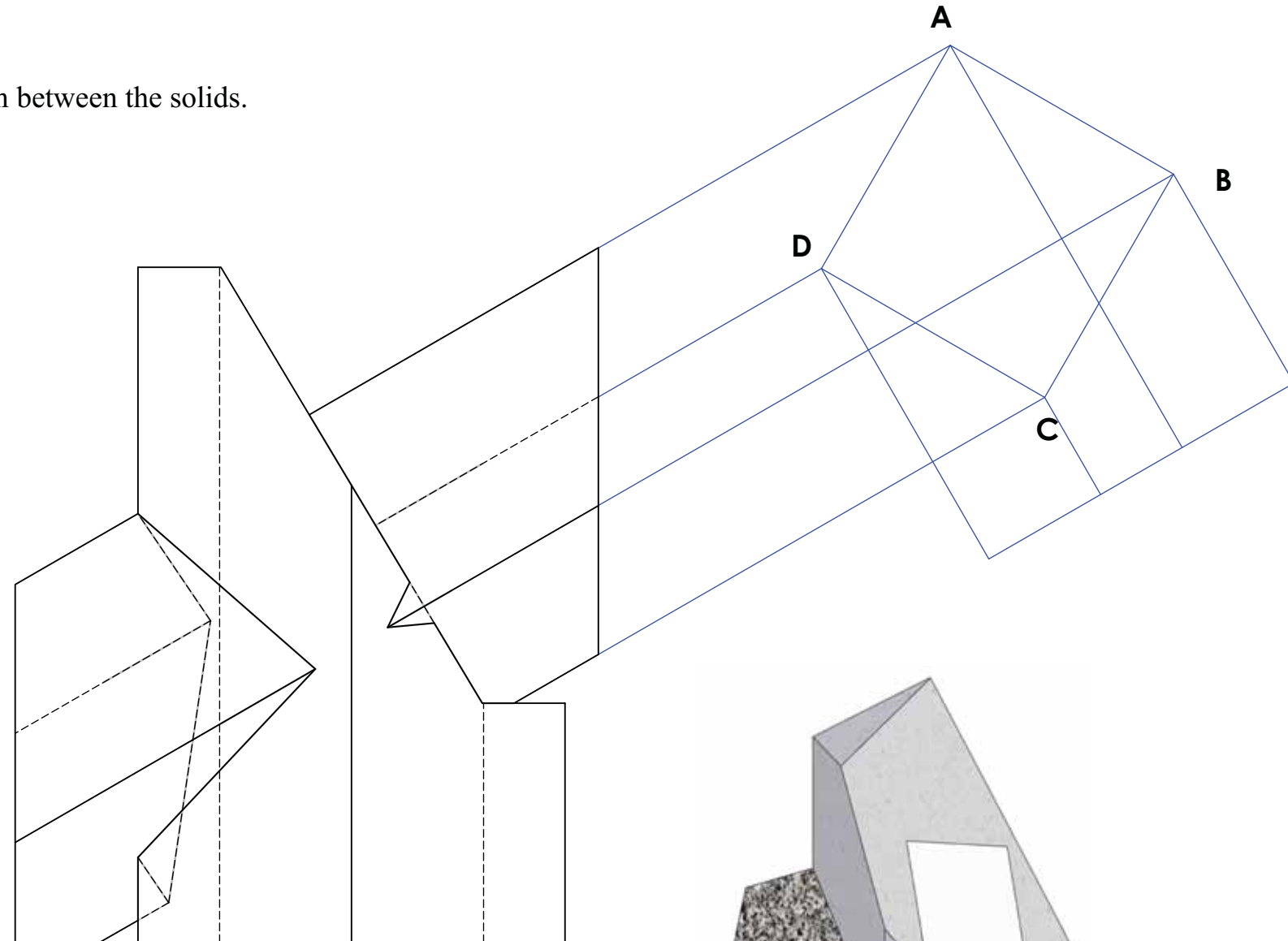
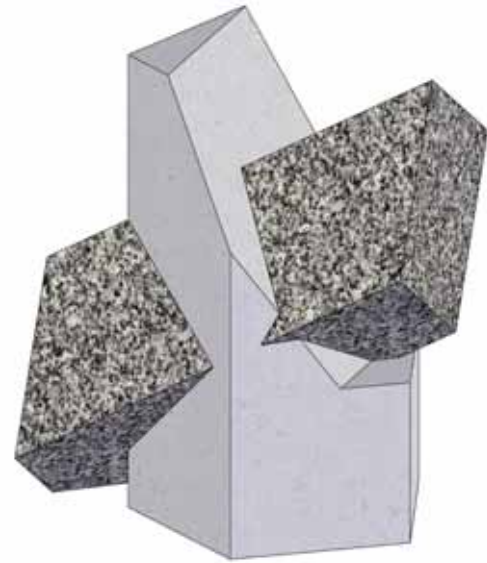

Shown is a pictorial view of a wood pellet hopper for feeding pellets to a stove.  
The upper piece of the hopper is in the shape of a truncated right cone.  
Also shown are the elevation and incomplete plan of the hopper.

- (a) Complete the plan.
- (b) Develop the curved surface of the truncated cone.

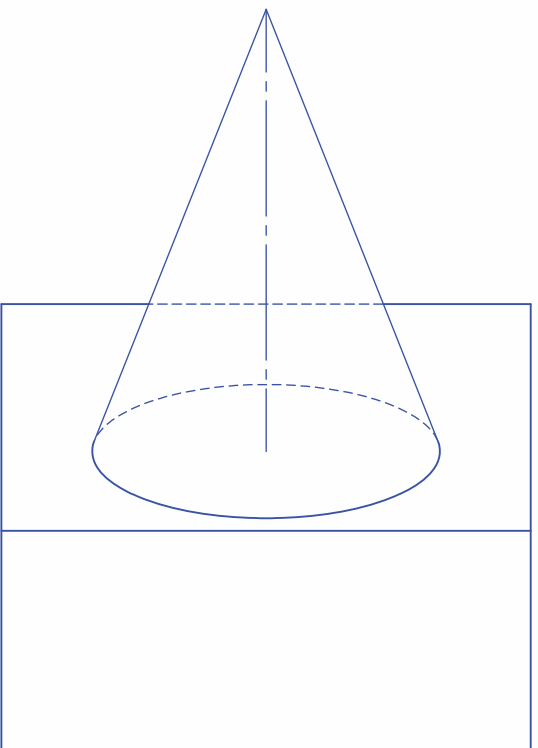
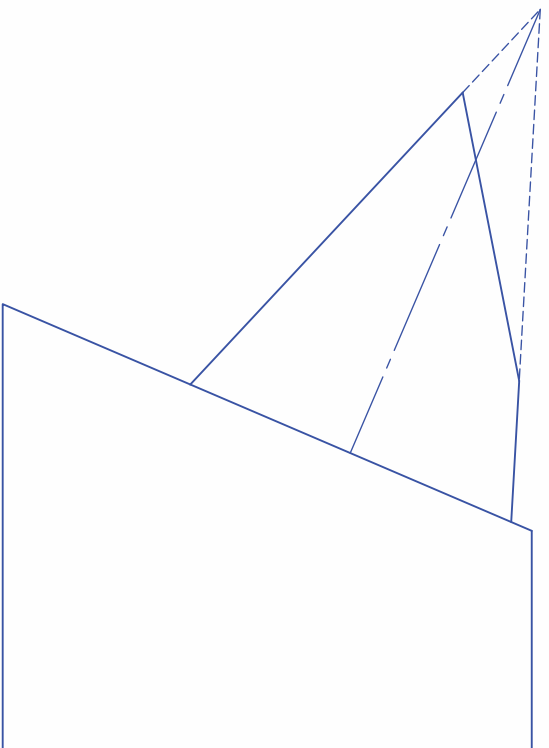
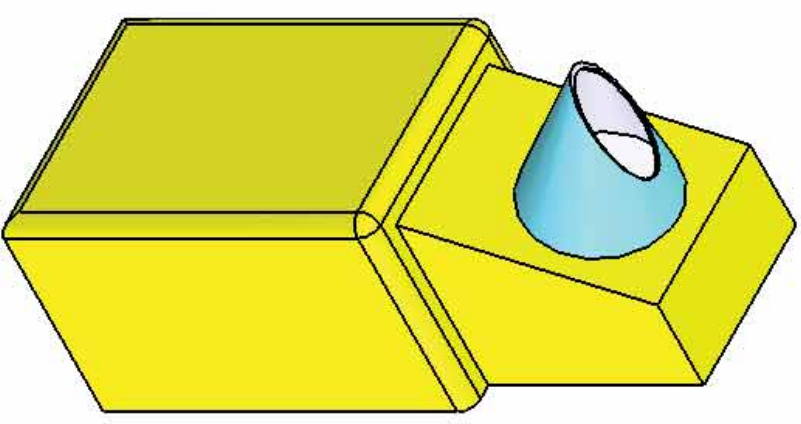

TECHNOLOGY  
SUBJECTS  
SUPPORT  
SERVICE

DESIGN & COMMUNICATION GRAPHICS  
Intersection & Development of Surfaces

NAME: \_\_\_\_\_

DATE: \_\_\_\_\_



Shown is a model of a pencil holder made from wood.

Also given are the plan and incomplete elevation of the pencil holder.

(a) Project an end view and complete the elevation.

(b) It is required to make the holder out of recycled cardboard. Draw a complete one piece development of the holder.

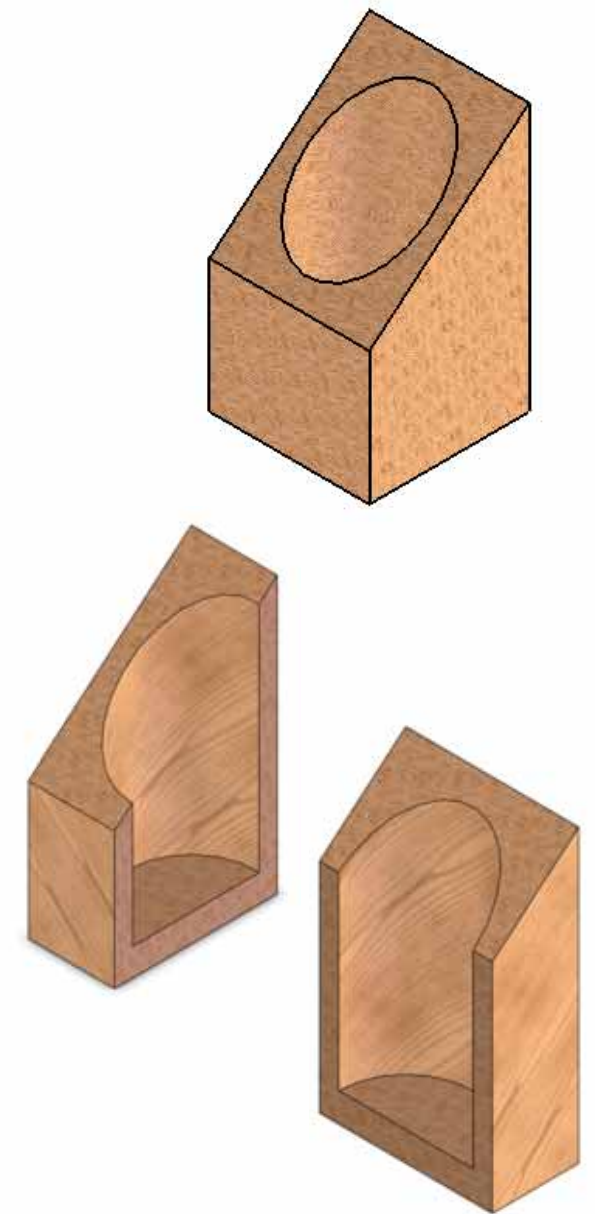
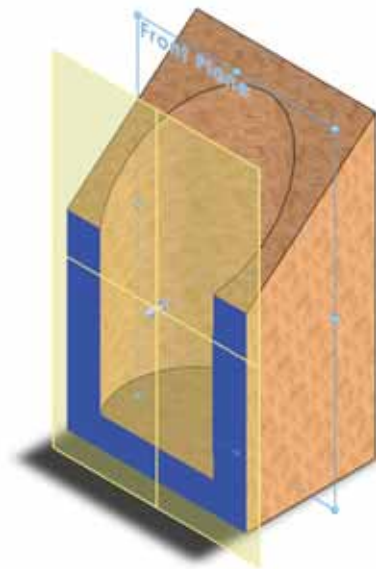
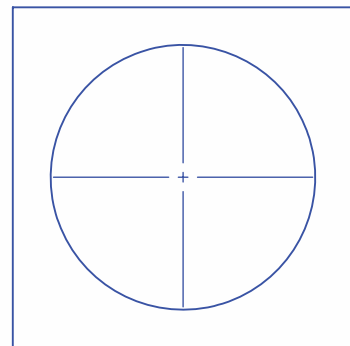
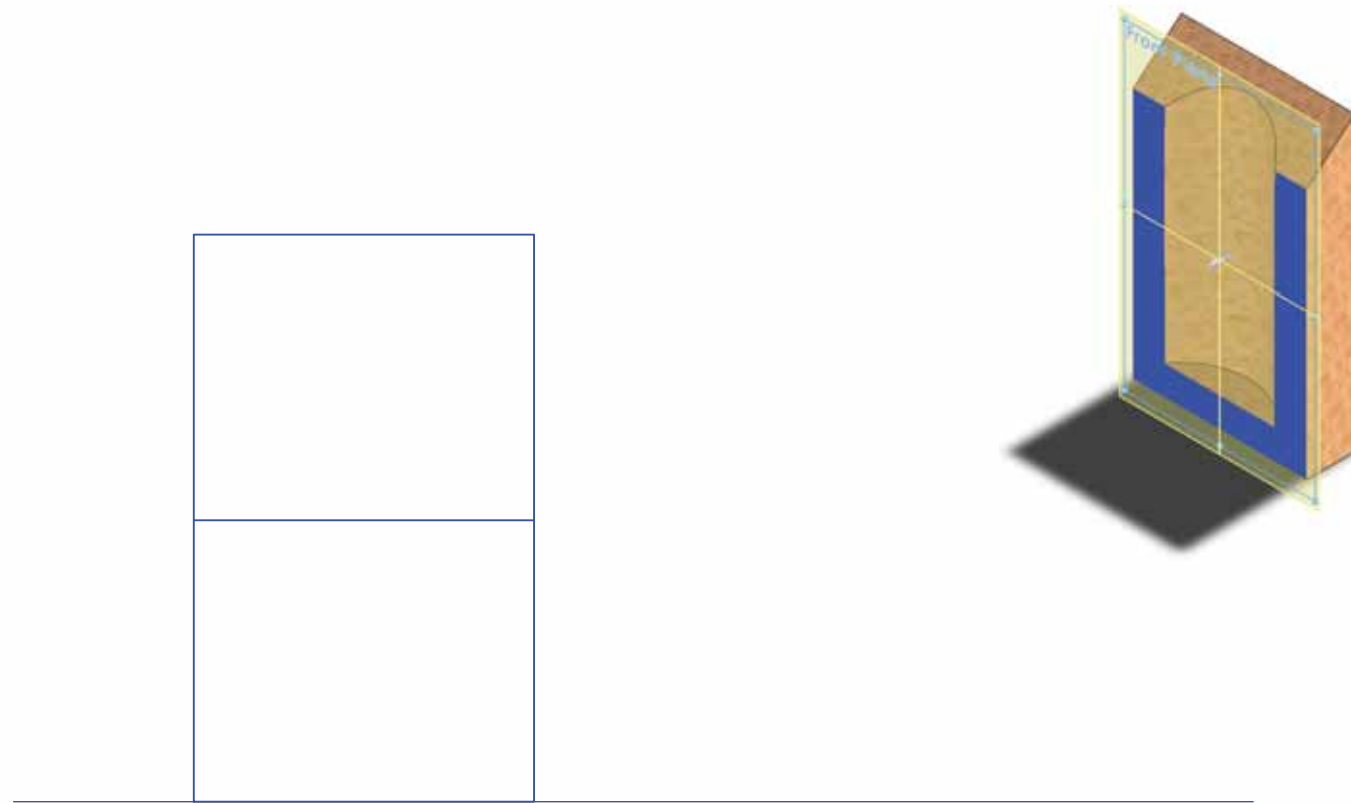





The 3D graphic on the left shows a number of arrows piercing an archery target board.

The projections of three points A, B and C on the archery board are given in the drawing below. The direction of one of the arrows EG is also given.

Find the point of intersection P of the line EG with the plane ABC using:

- (i) A vertical cutting plane N that contains the line EG
- (ii) A cutting plane M perpendicular to the V.P. that contains the line EG
- (iii) An auxiliary view showing the plane as an edge

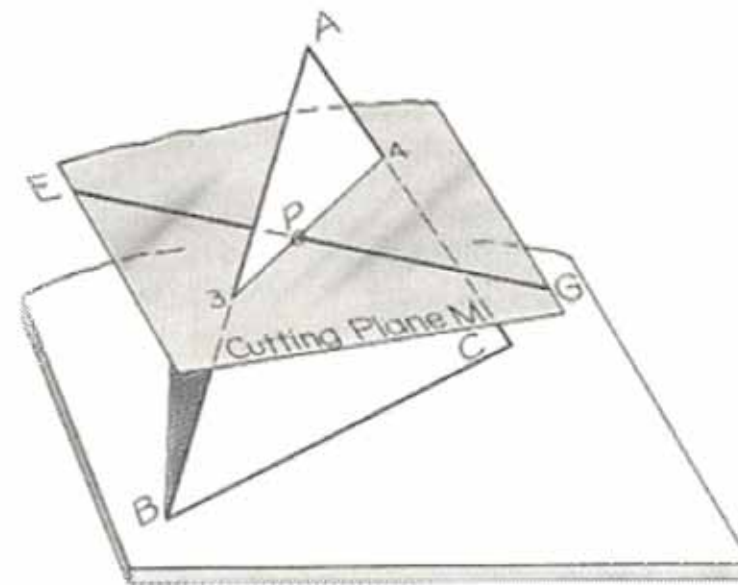
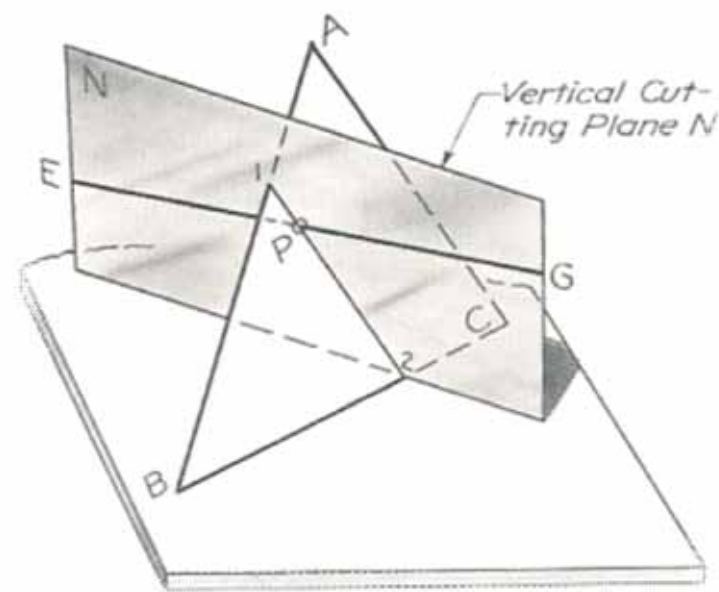
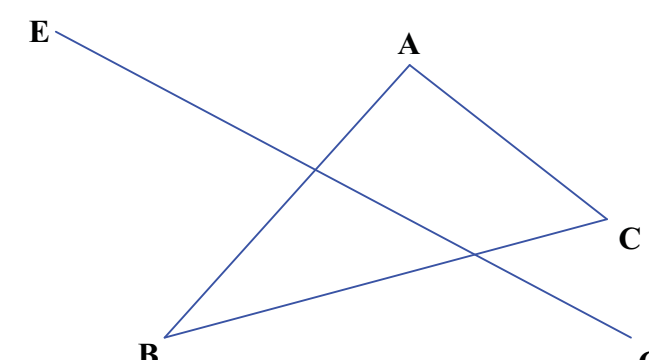
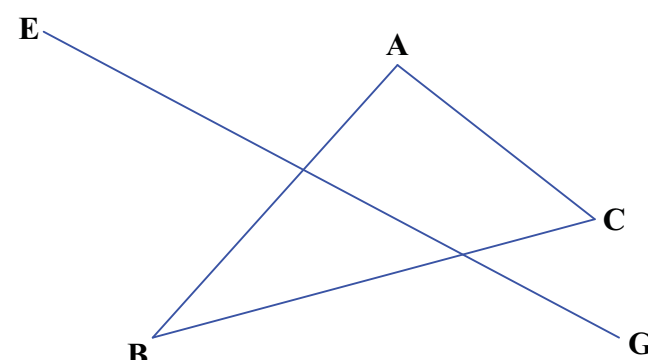
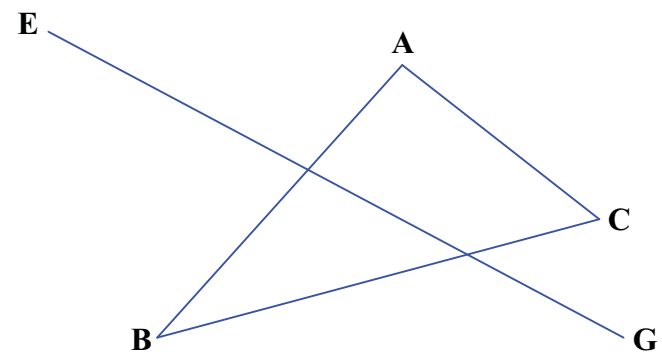
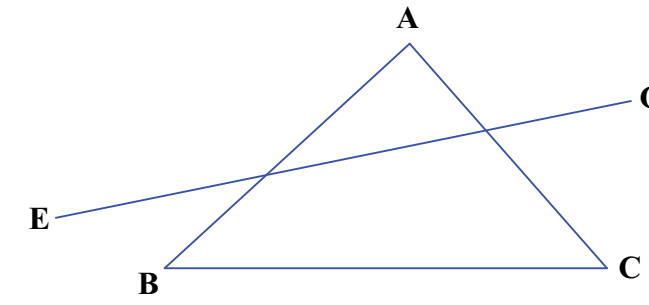
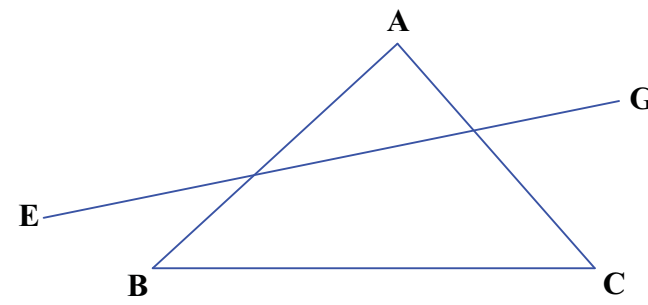
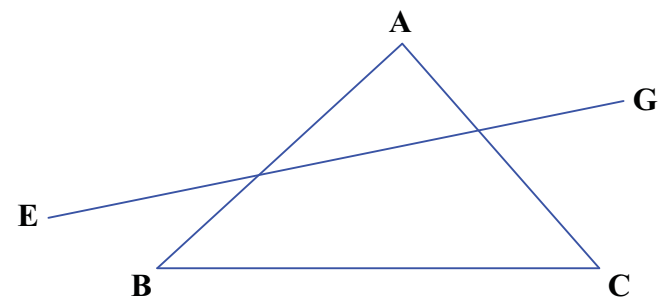

**Key Principles:**

- (i) The vertical cutting plane N appears as an edge view in plan
- (ii) The cutting plane M appears as an edge view in elevation
- (iii) An auxiliary view showing the plane ABC as an edge gives the point of intersection





The 3D graphic on the left shows a trophy which is to be awarded for an archery competition. The main body of the trophy consists of a square based pyramid which is penetrated by a shaped solid representing the arrow as shown.

The projections of part of a similar trophy are given below. The drawing shows a square based right pyramid which has been cut as shown. Also shown are the projections of a shaped solid which penetrates the cut pyramid. A 3D graphic of the intersecting solids is also given.

- (i) Use a horizontal cutting plane to determine the points of intersection of the lines AB and DE with the pyramid.
- (ii) Use vertical cutting planes to determine the points of intersection of the lines AC and DF with the pyramid.
- (iii) Use another cutting plane to determine the remaining points of intersection (turning points).
- (iv) Join the points of intersection in order and complete the drawing showing hidden detail.

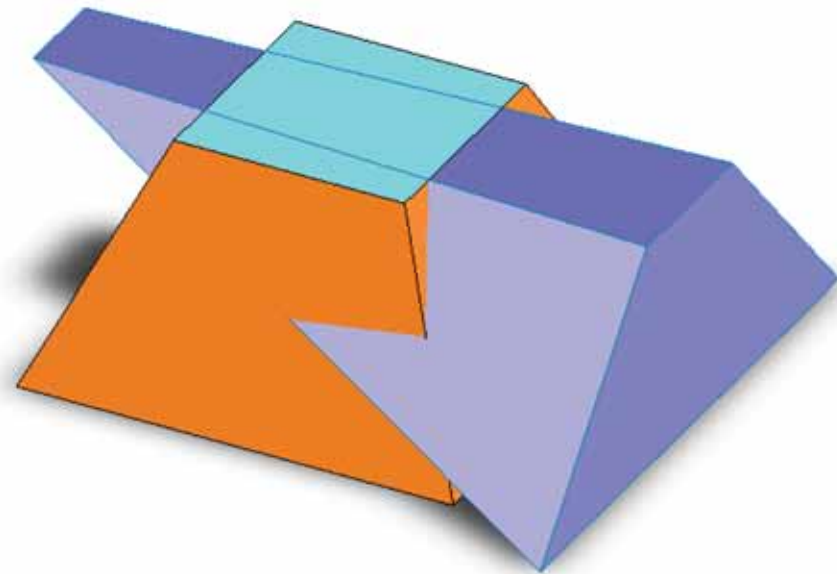
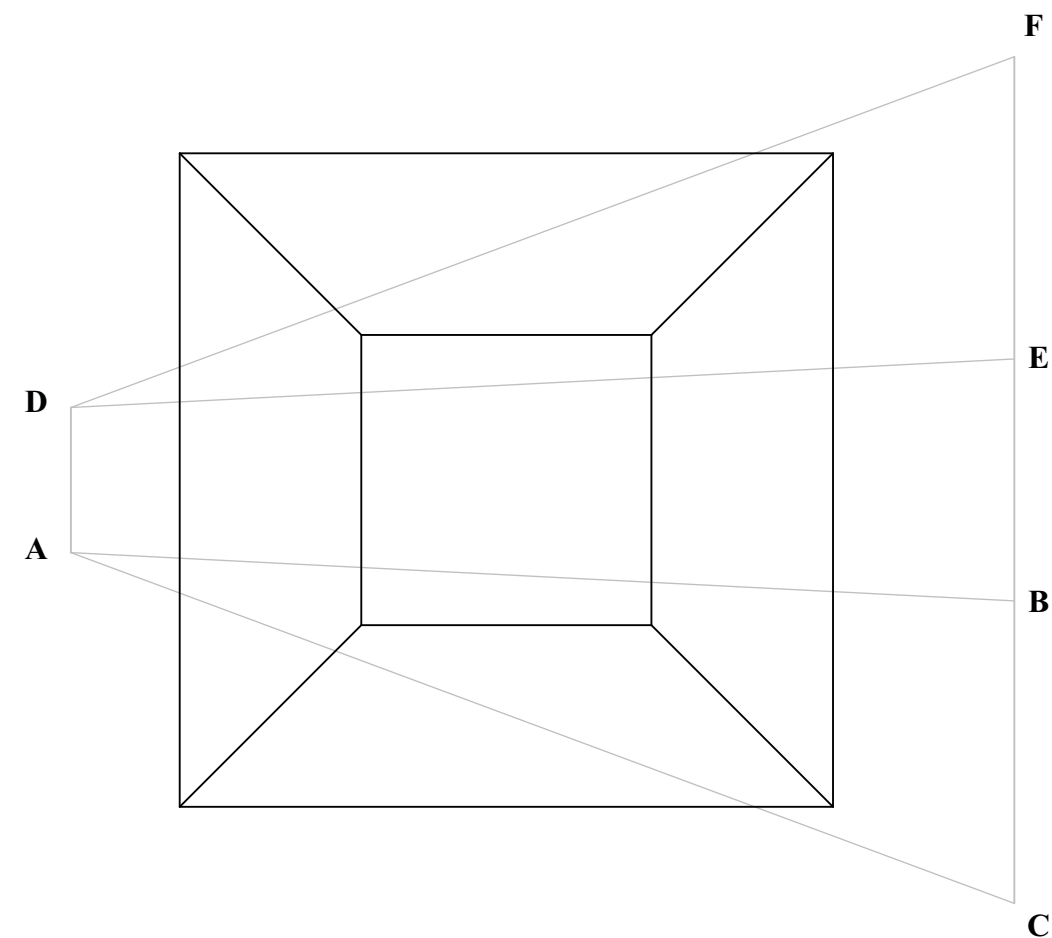
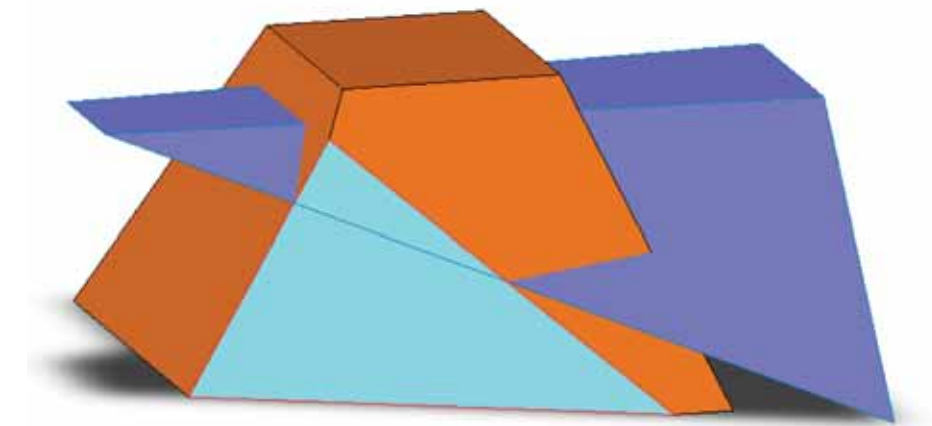
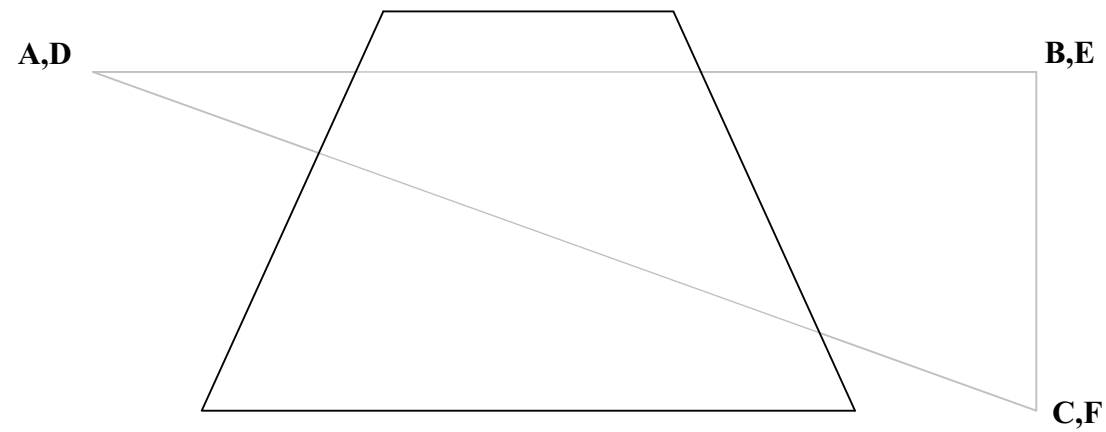
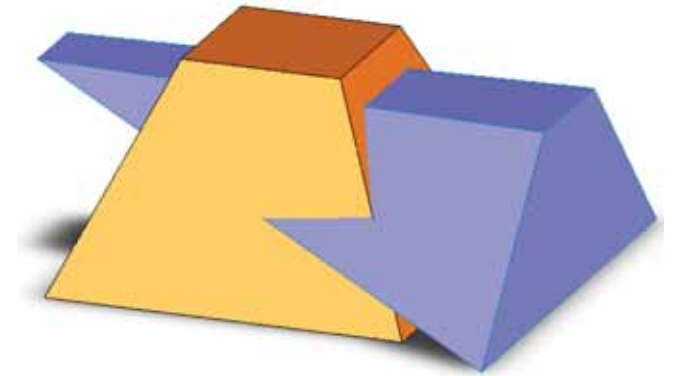

The 3D graphic shows a package for potato chips based on a hexagonal prism. Also shown is a solid model of a cardboard container to store the potato chips. A rectangular hole is cut in the side of the box to allow the consumer to see the contents.

The plan, incomplete elevation and end elevation are shown below.

- (a) Complete the elevation and end elevation of the container.
- (b) Determine the true shape of the lid.

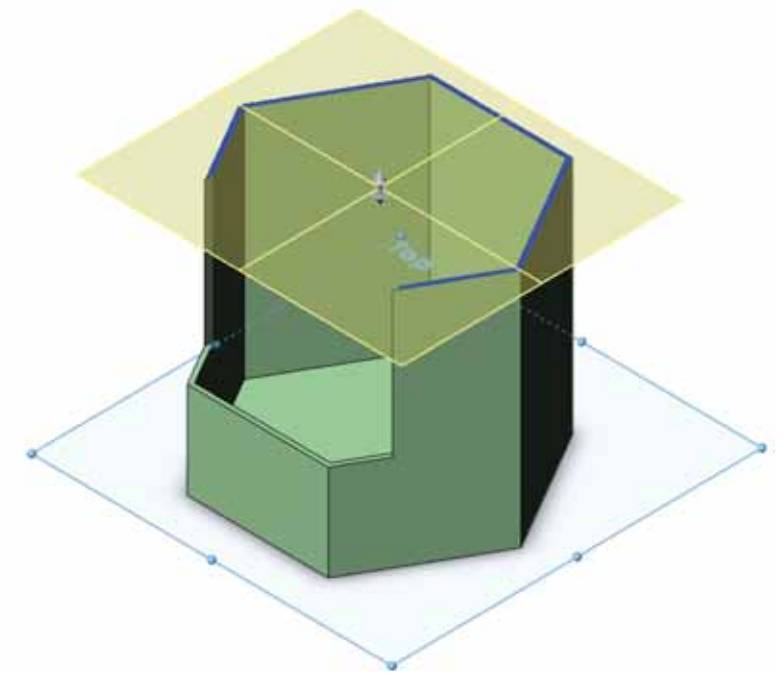
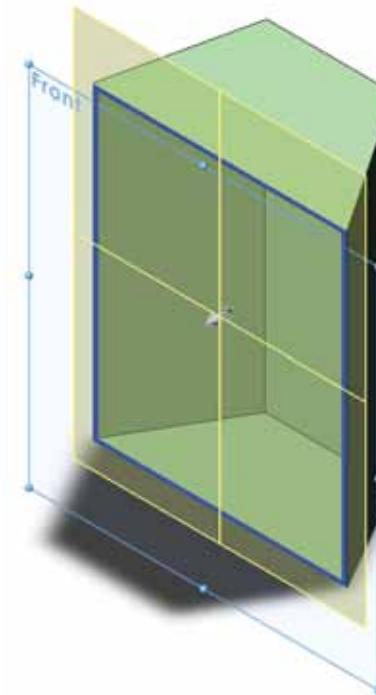
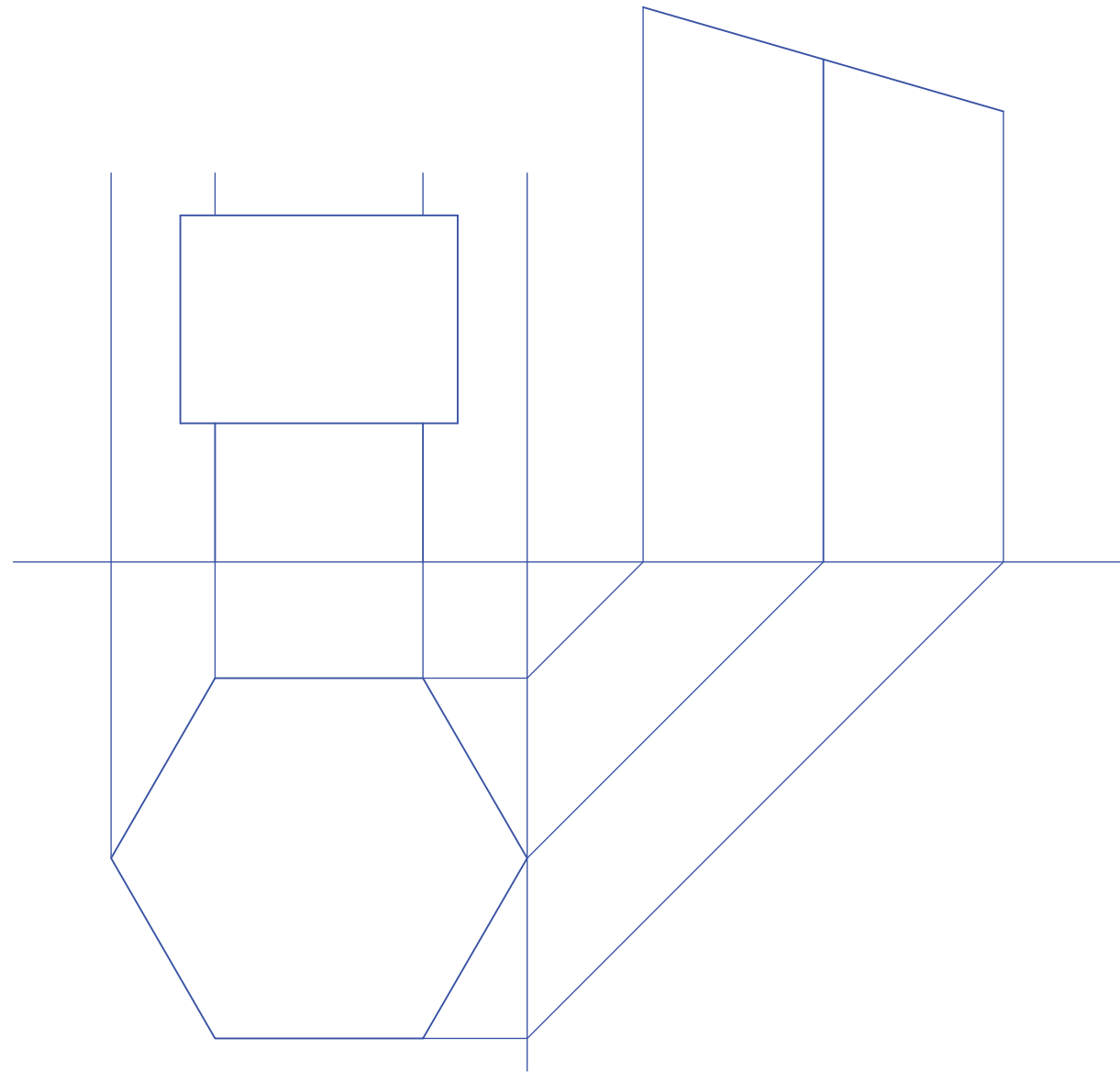
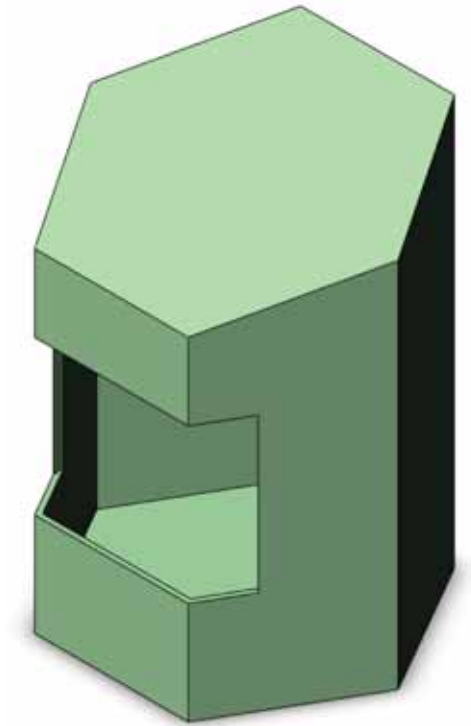

Shown are the elevation and plan of a cube and a square based pyramid. Also shown are two points A and B on the surface of each.

Point A is at the front while point B is at the back.

Determine the projection of the shortest distance between points A and B on the surface of each solid.

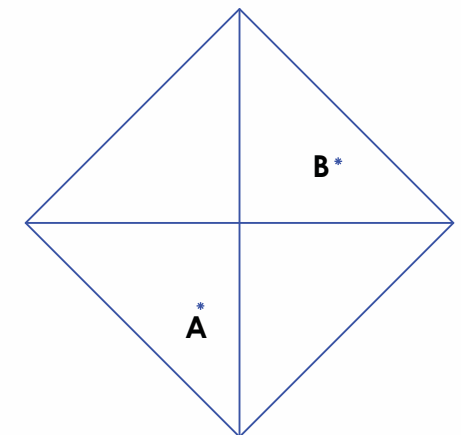
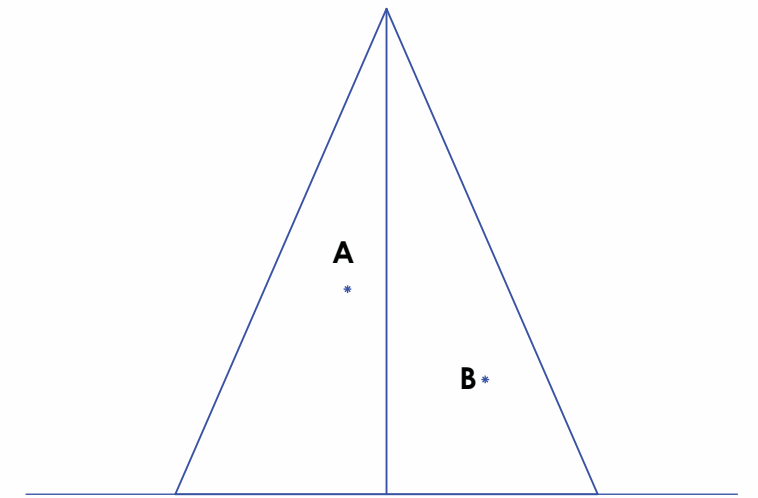
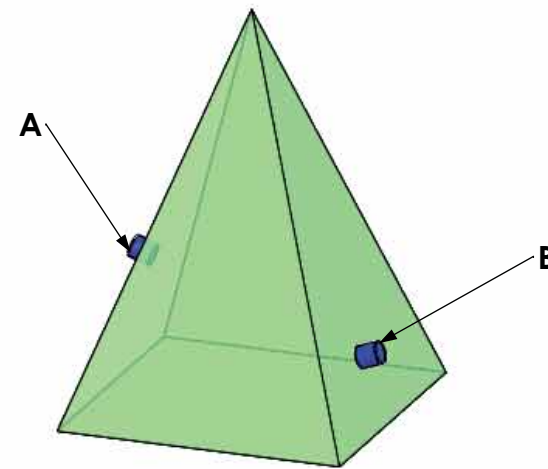
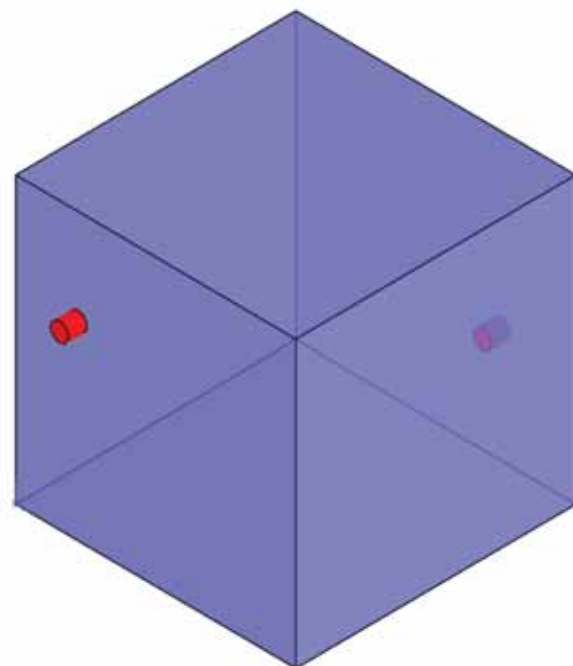
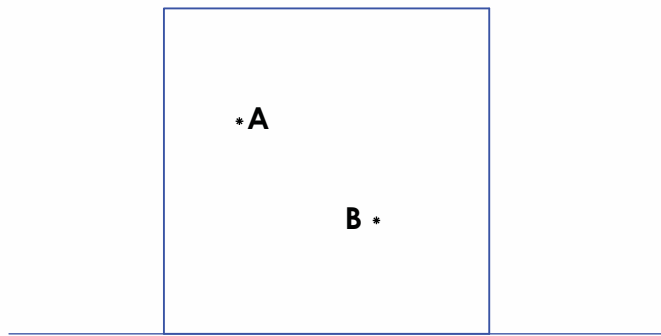



The 3D graphic on the right shows a tennis ball package based on an irregular hexagonal prism. The opening is rectangular in shape.

The drawing below shows the plan and elevation of the hexagonal prism.

- (a) Project an end view of the package looking in the direction of the arrow A.
- (b) Draw the surface development of the opening.
- (c) A set of trimetric axes are shown. The elevation and plan of the package are also shown in their required positions. Complete the trimetric projection of the package.

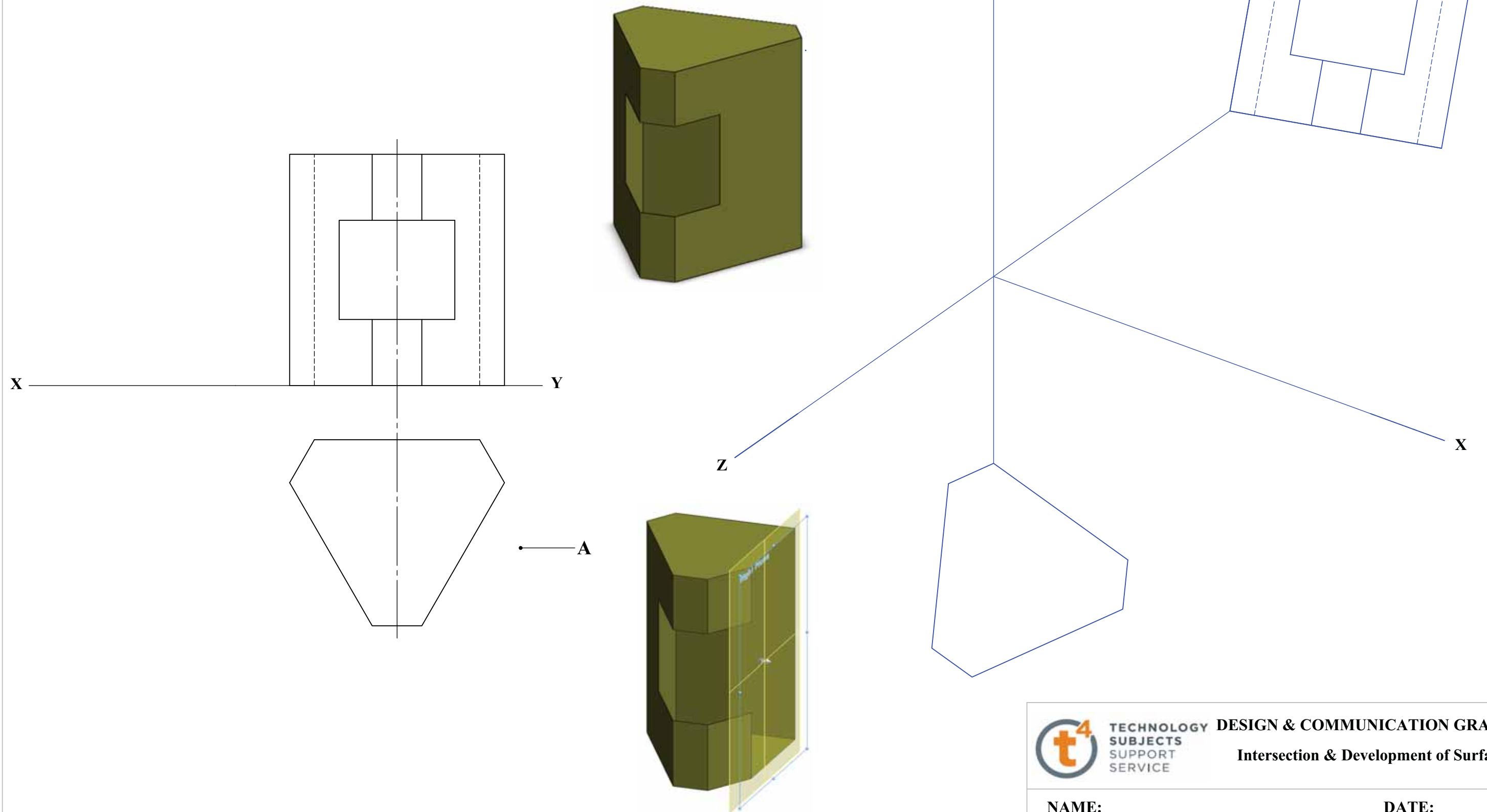



The 3D graphic on the right shows a camping tent. It is composed of a triangular prism intersecting a square-based pyramid.

The drawing below shows the incomplete elevation and end view of the tent.

Project a plan of the solids and complete the elevation and plan showing all lines of interpenetration.

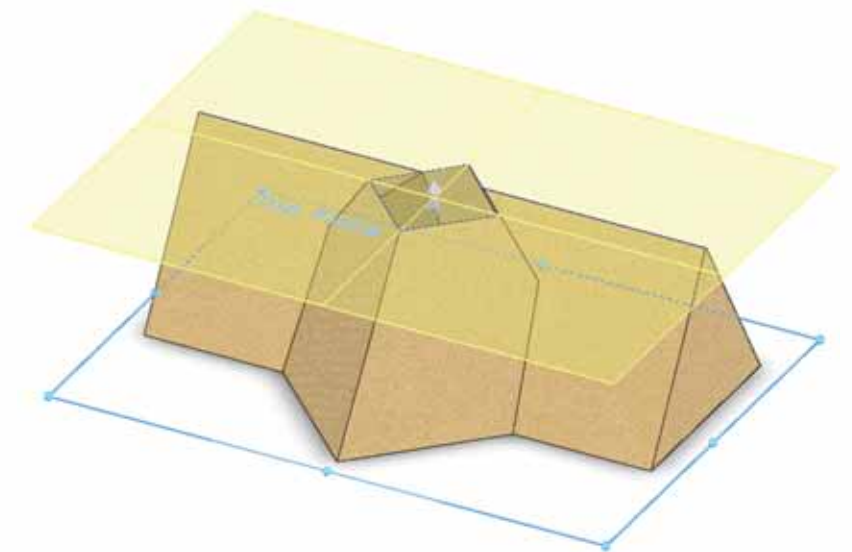
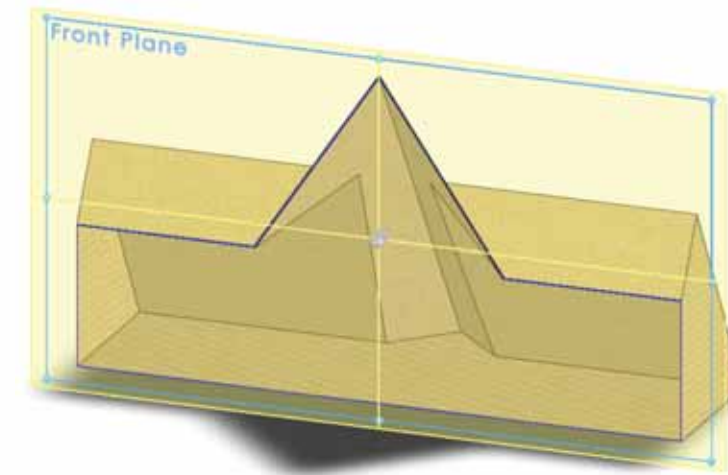
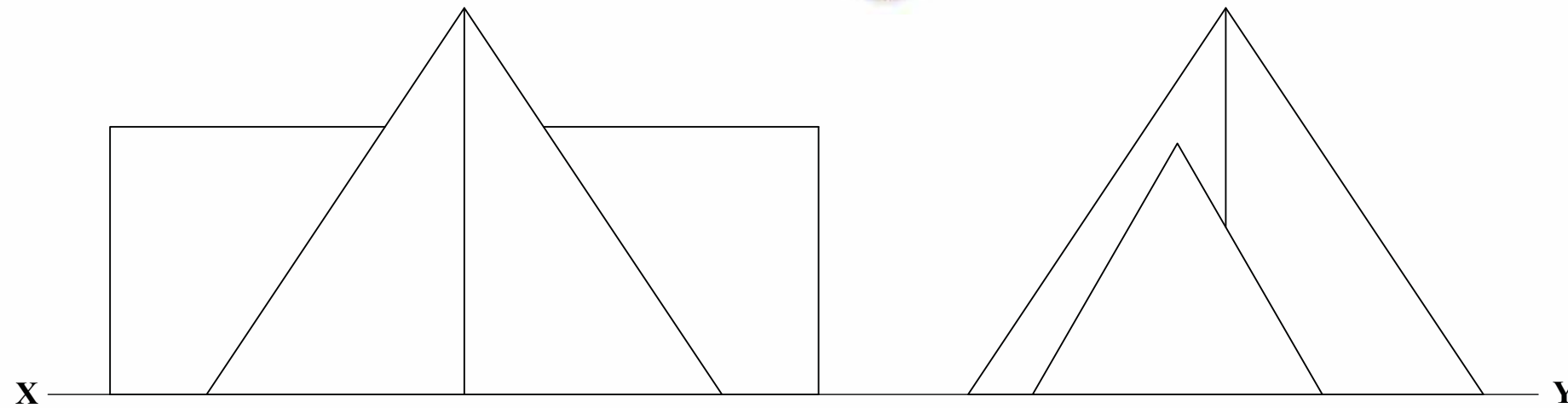
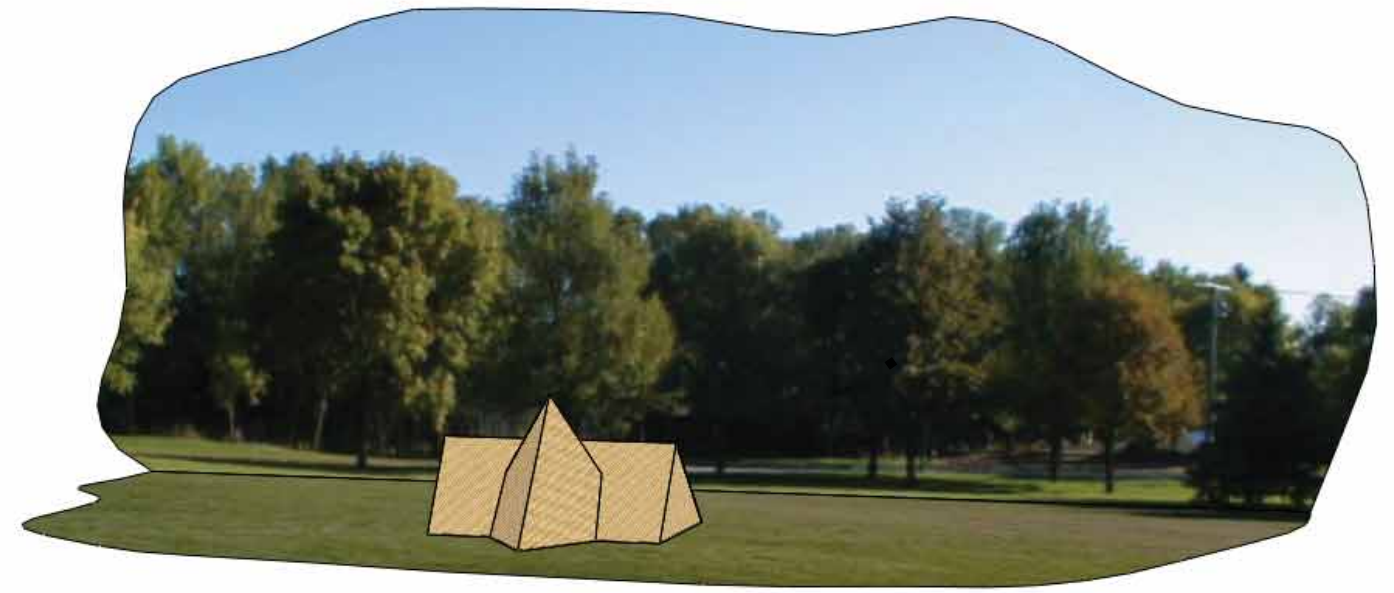
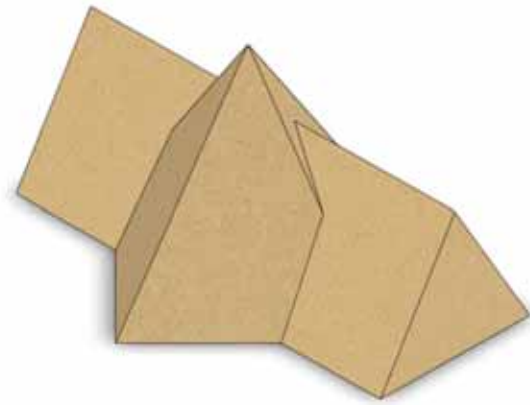

Toblerone is famous for its triangular shape. The 3D graphic on the right shows a Toblerone package intersecting a piece of the chocolate bar.

The drawing below shows the elevation and incomplete plan of part of the arrangement, where a solid resting on the horizontal plane is intersected by a triangular prism.

Project an end elevation of the solids and complete the plan showing all lines of interpenetration.

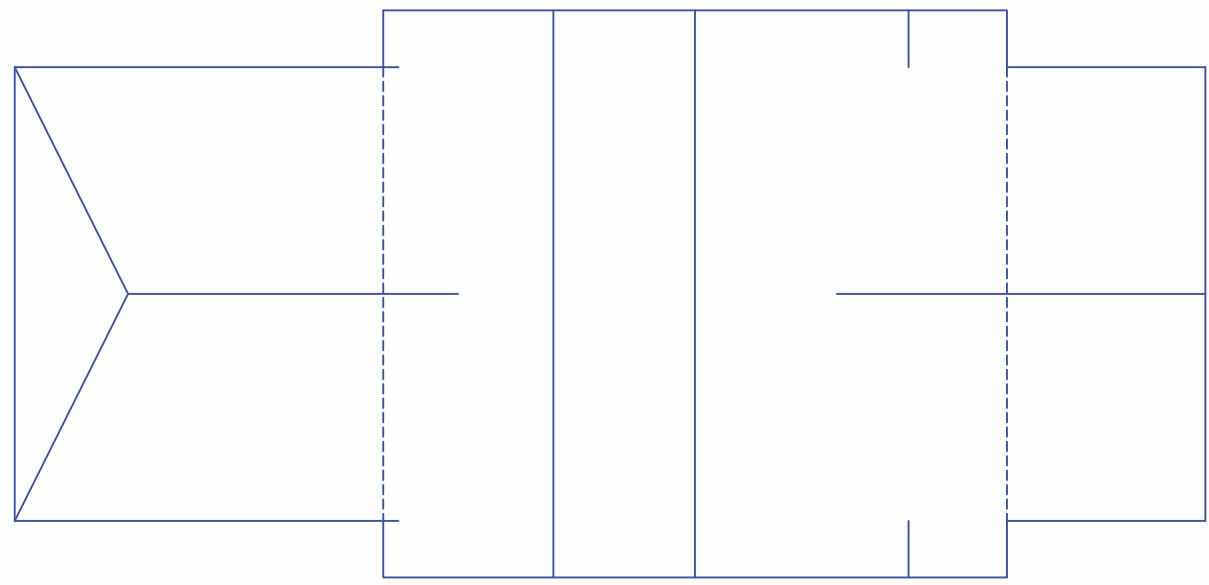
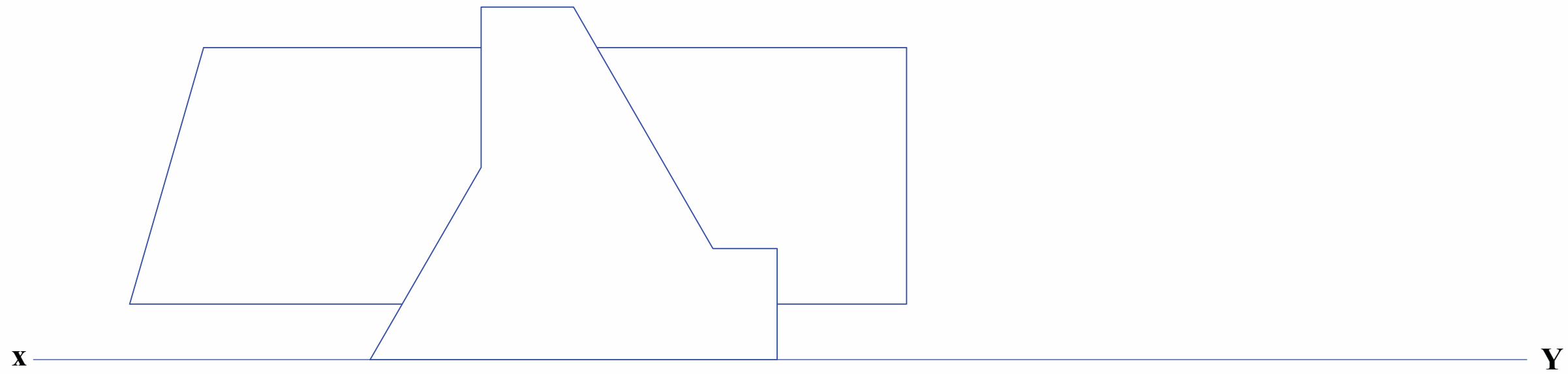

NAME: \_\_\_\_\_ DATE: \_\_\_\_\_