

The plan of a water feature is shown. The height of the paving slabs are 10mm thick.
Make a perspective drawing of the water feature when the position of the spectator and picture plane are as shown. The horizon line and vanishing point are also shown.
Draw the perspective view of the model.

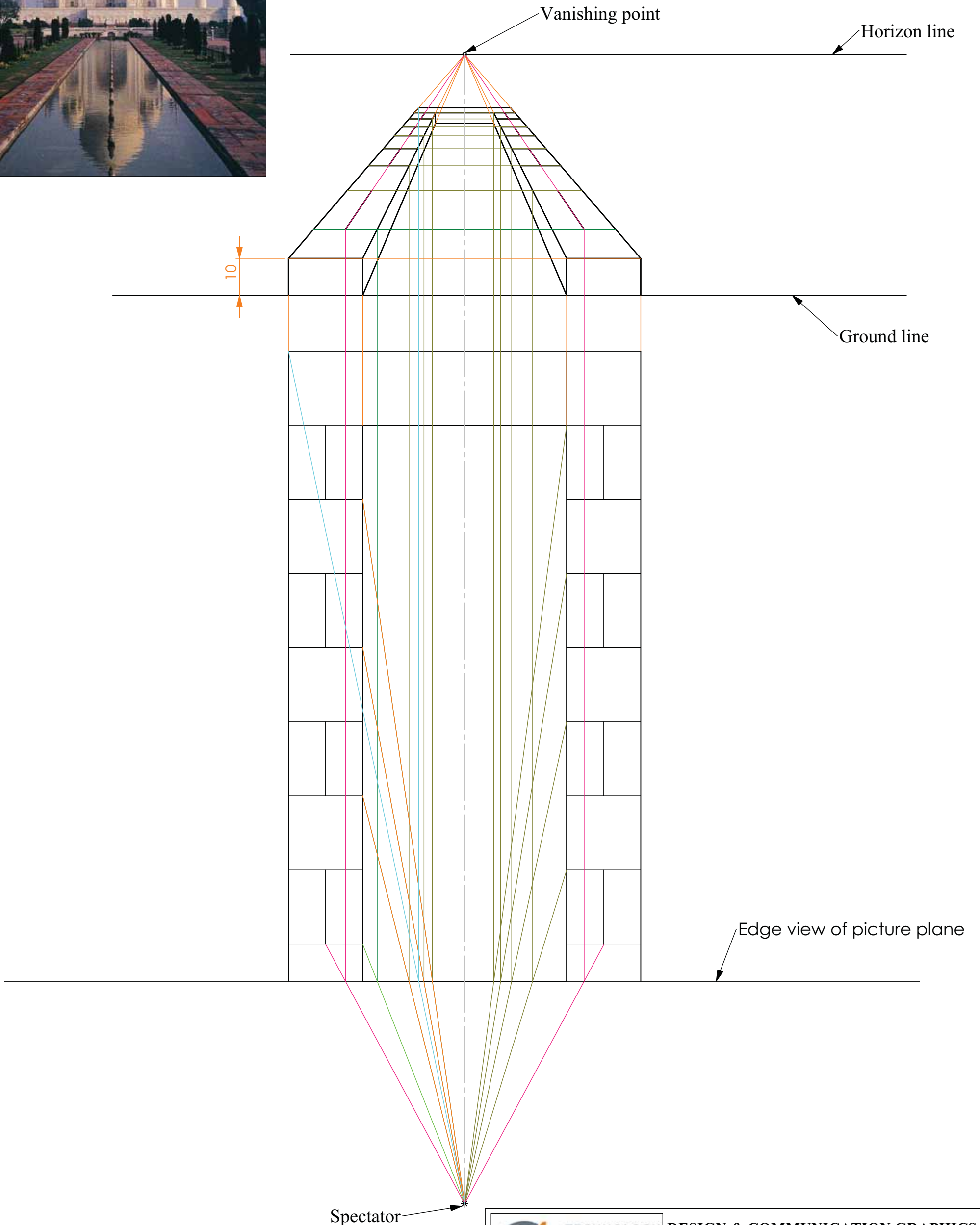

DESIGN & COMMUNICATION GRAPHICS

PERSPECTIVE PROJECTION 1

Name: _____ Date: _____

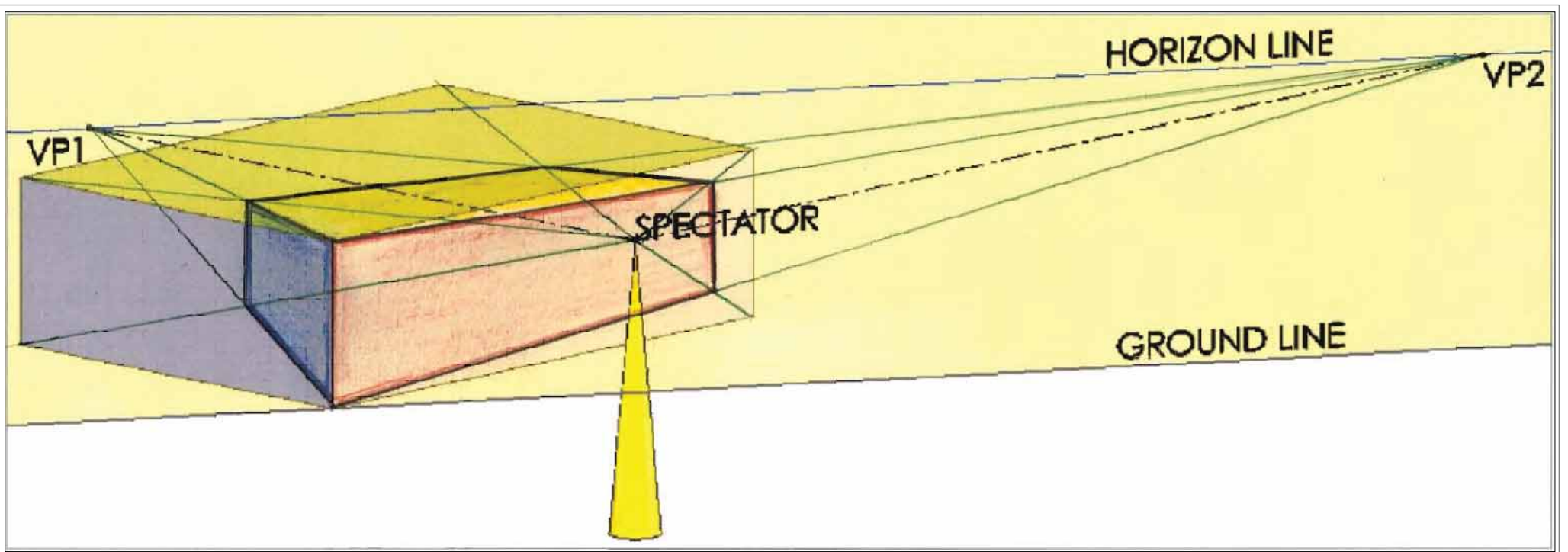

(3D View not to scale)

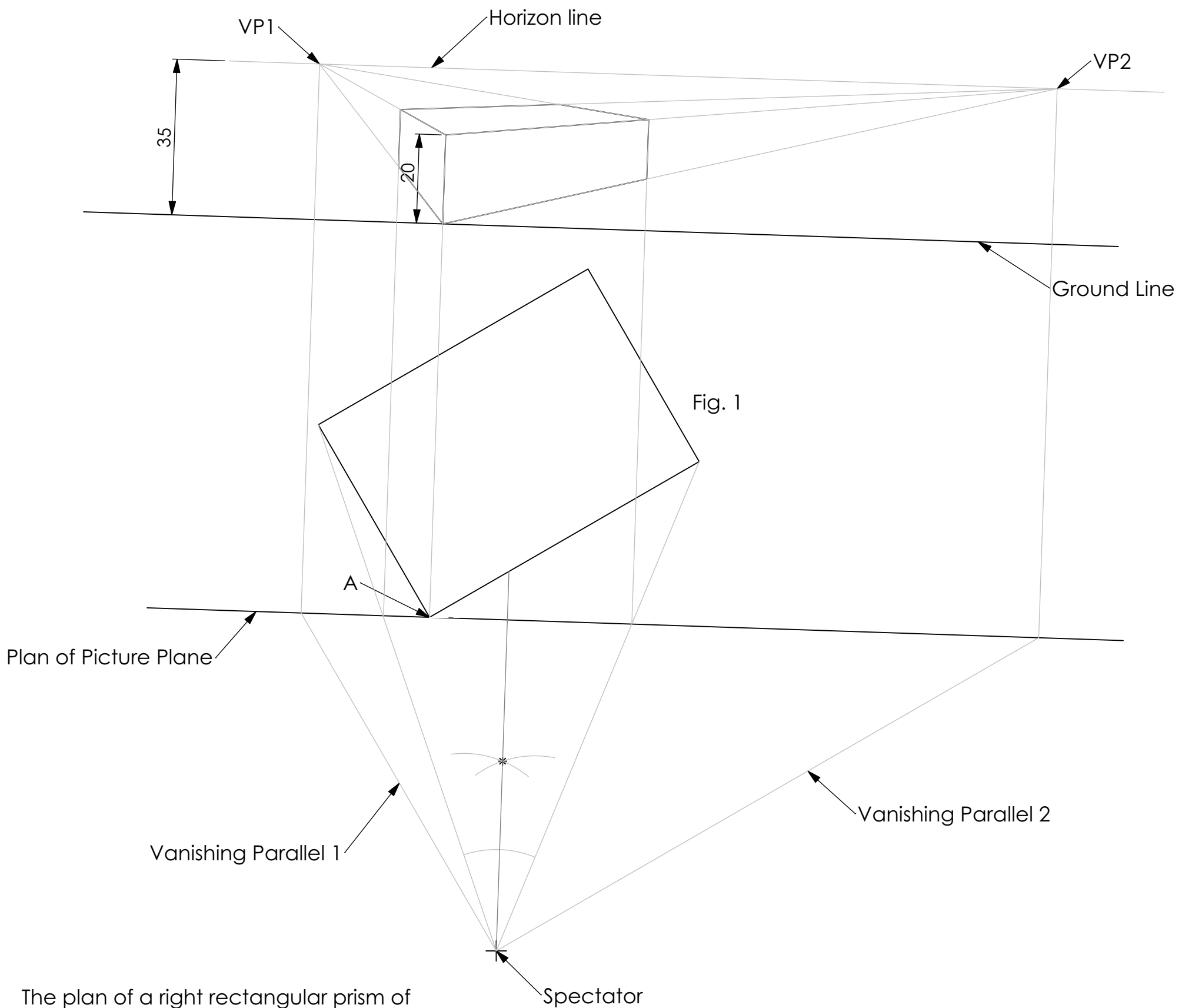

The plan of a right rectangular prism of height 20mm which rests on the ground plane is shown in Fig.1. Also shown is the position of the spectator. The picture plane passes through corner A and the horizon line is 35mm above the ground line.

Draw a perspective view of the prism.

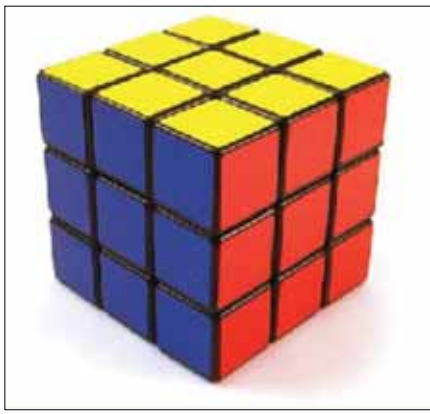

The plan of a Rubex Cube is shown. Also shown is the position of the spectator and picture plane. The horizon line is 85mm above the ground line. Draw the perspective view.

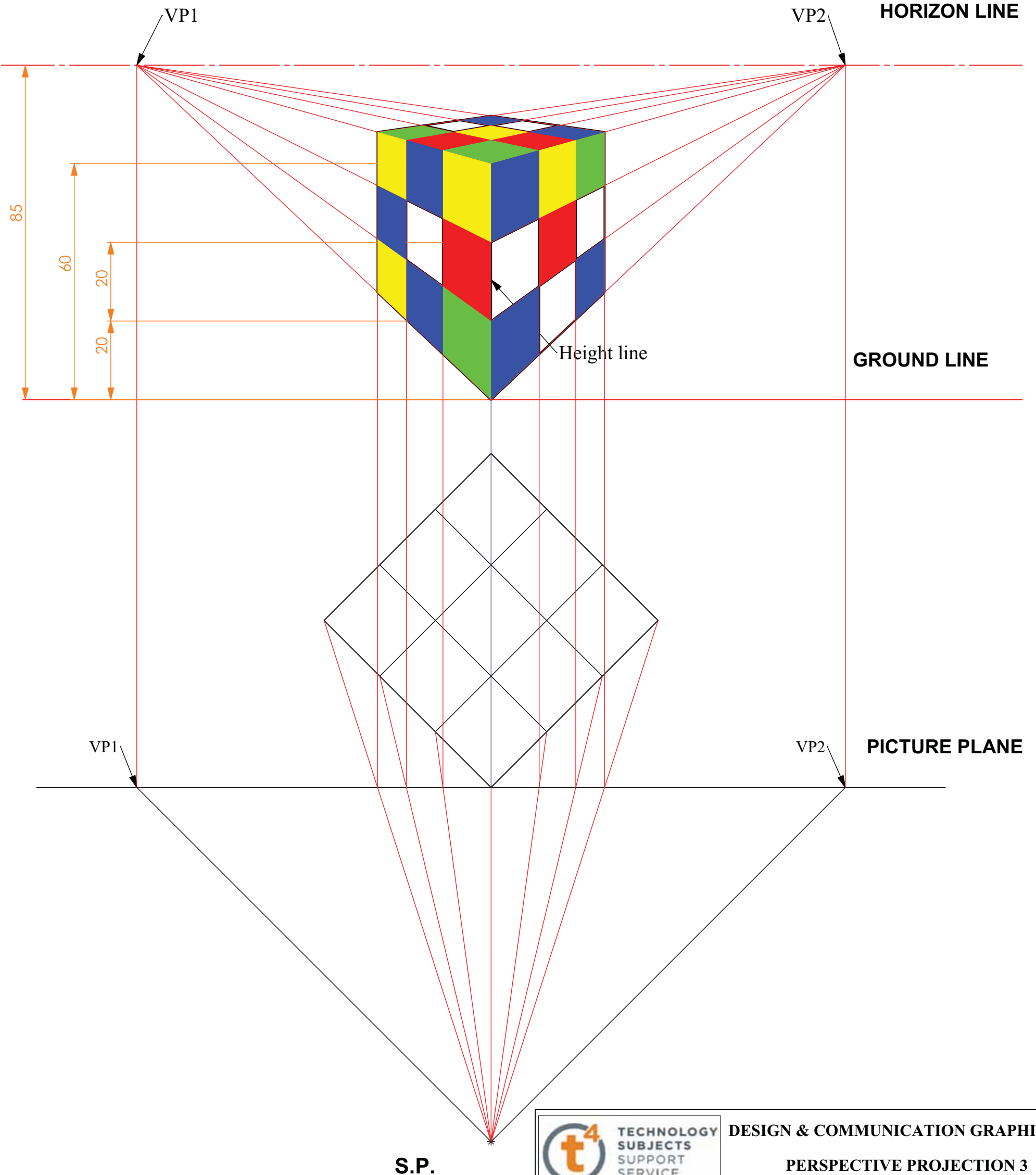

Name: _____ Date: _____

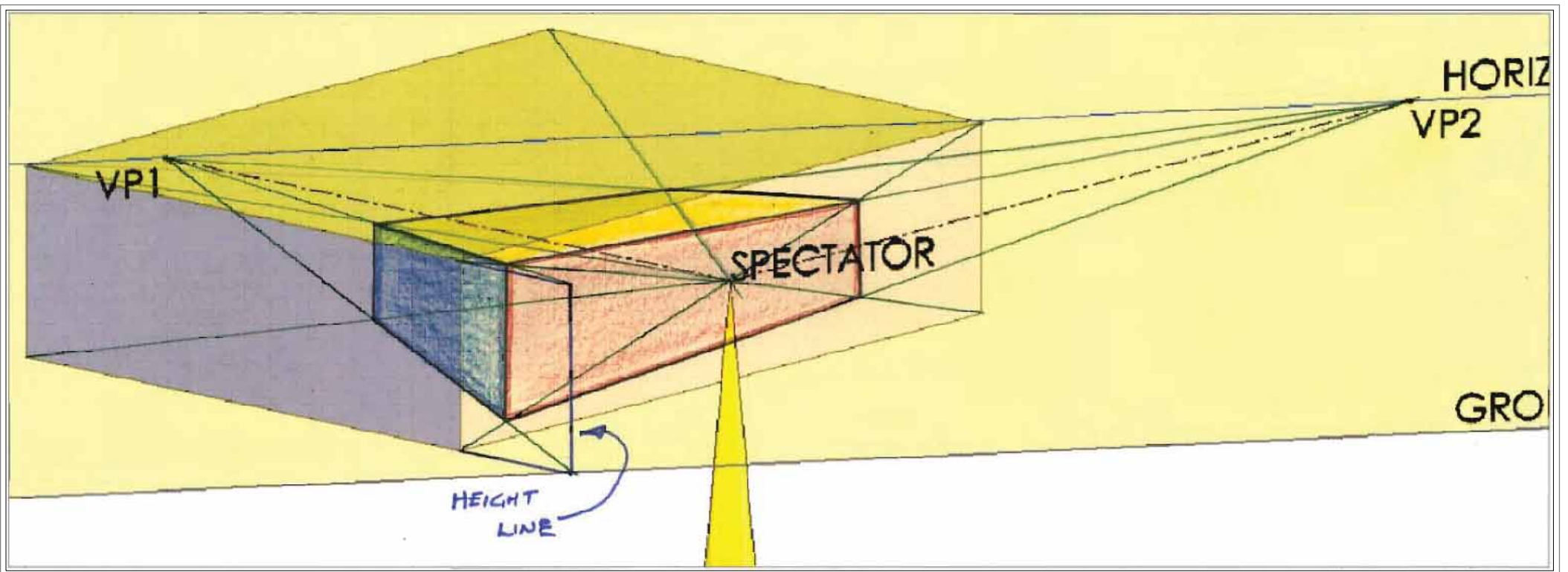

(3D View not to scale)

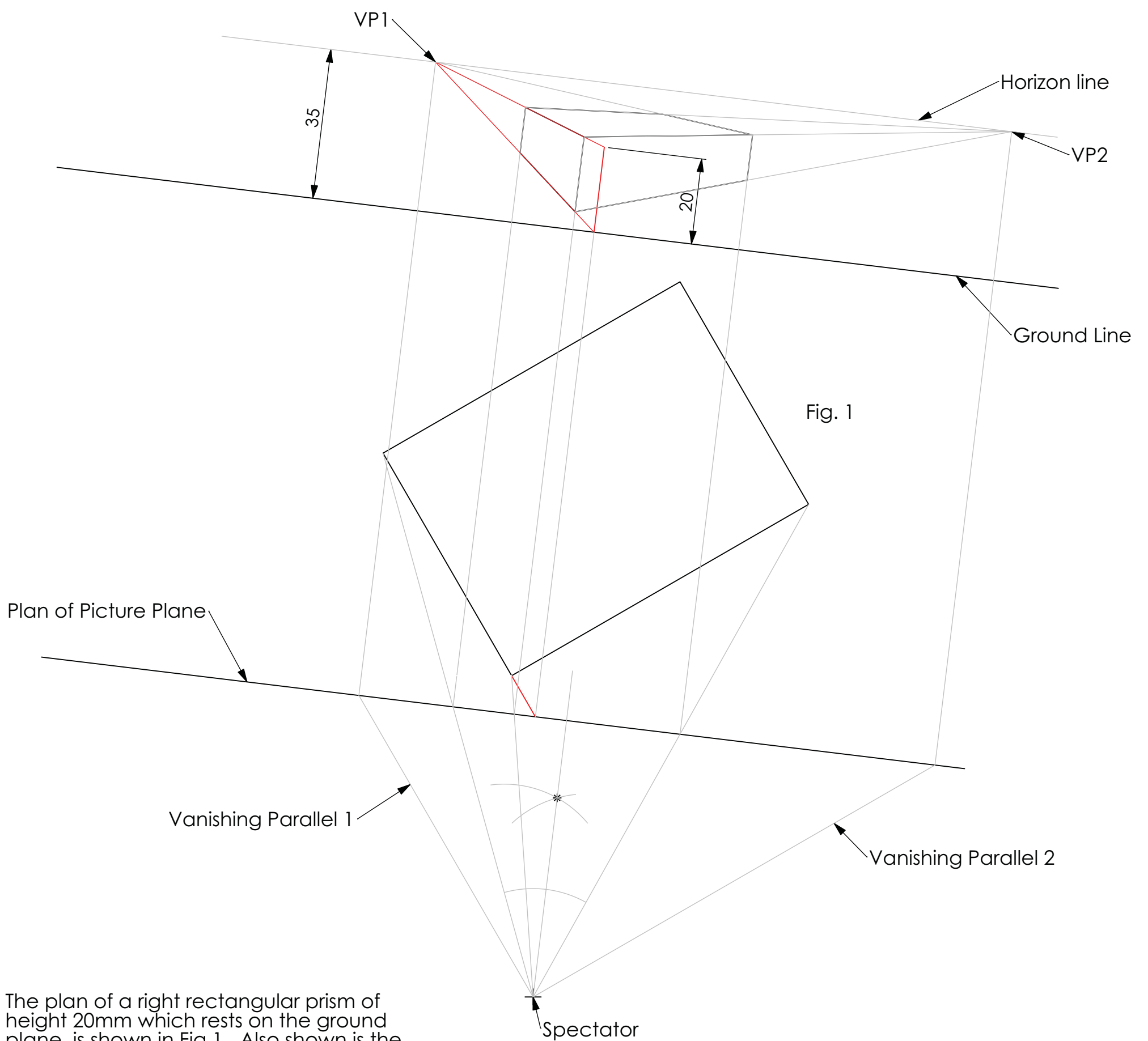

The plan of a right rectangular prism of height 20mm which rests on the ground plane is shown in Fig.1. Also shown is the position of the spectator. The picture plane is located 65mm from the spectator and the horizon line is 35mm above the ground line.

Draw a perspective view of the prism.

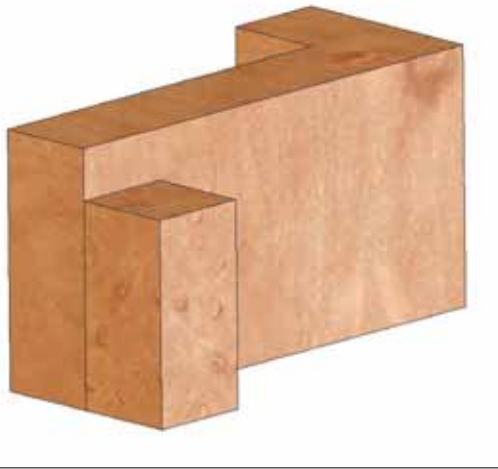

The outline plan and elevation of a bench hook are given. A 3D graphic view of the object is also shown. Make a perspective drawing of the bench hook when the position of the spectator is as shown, the picture plane is touching the corner A and the horizon line is 85mm above the ground line.

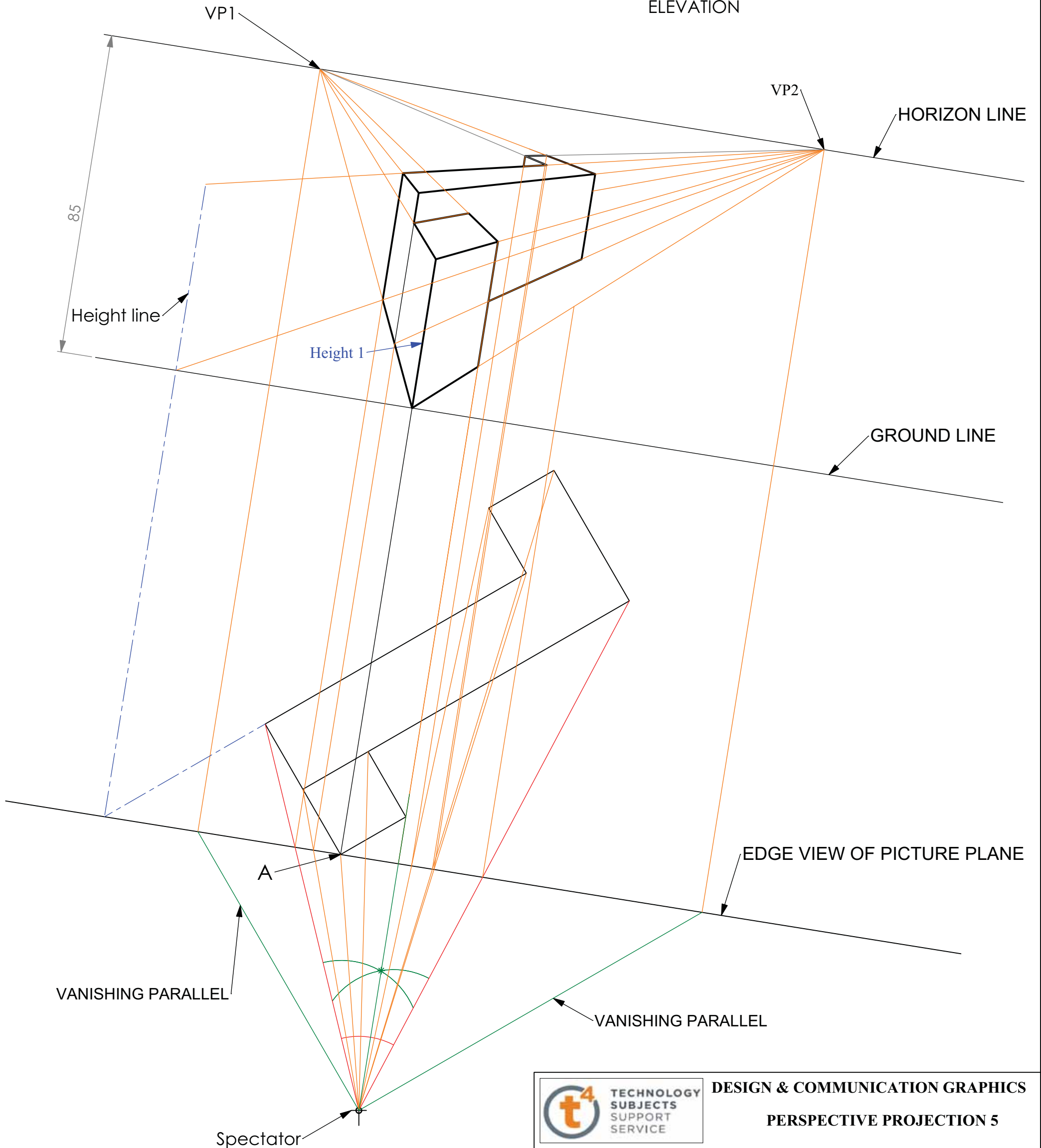
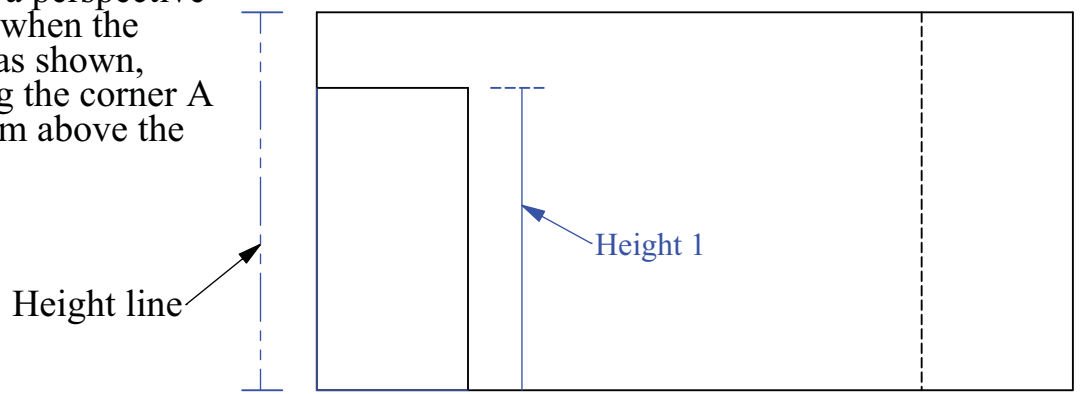



The plan and section view of the entrance steps are shown. Make a perspective drawing of the steps when the position of the spectator is as shown, the picture plane touches corner A and the horizon line is 80mm above the ground line.

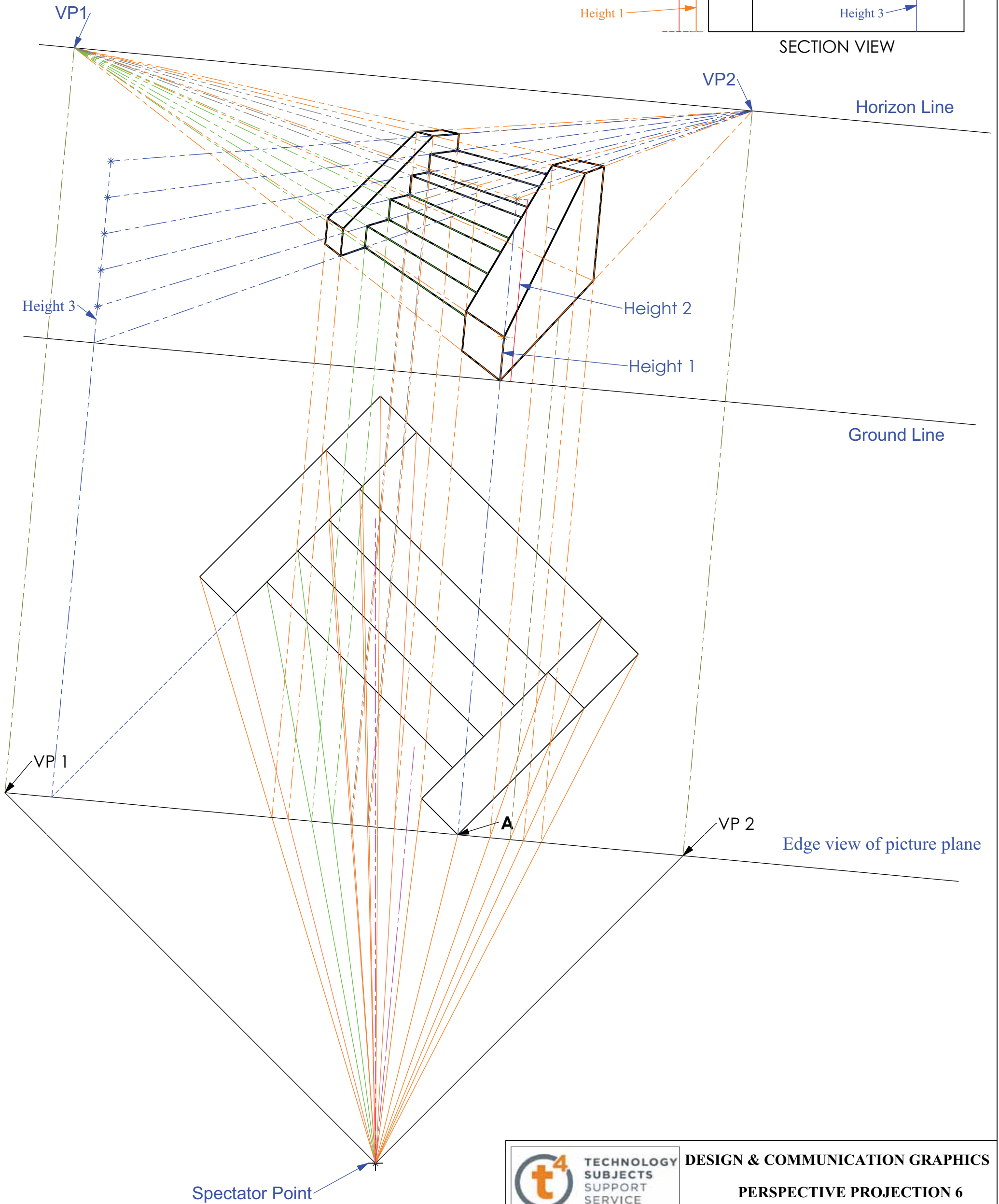
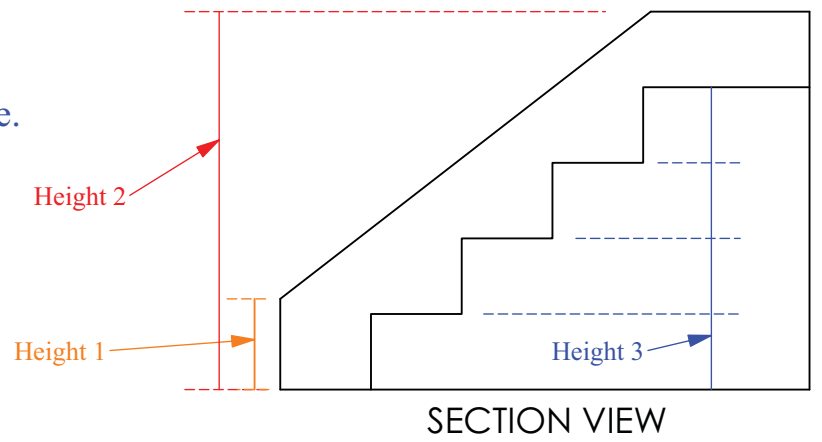



Height 1.

Height 2.

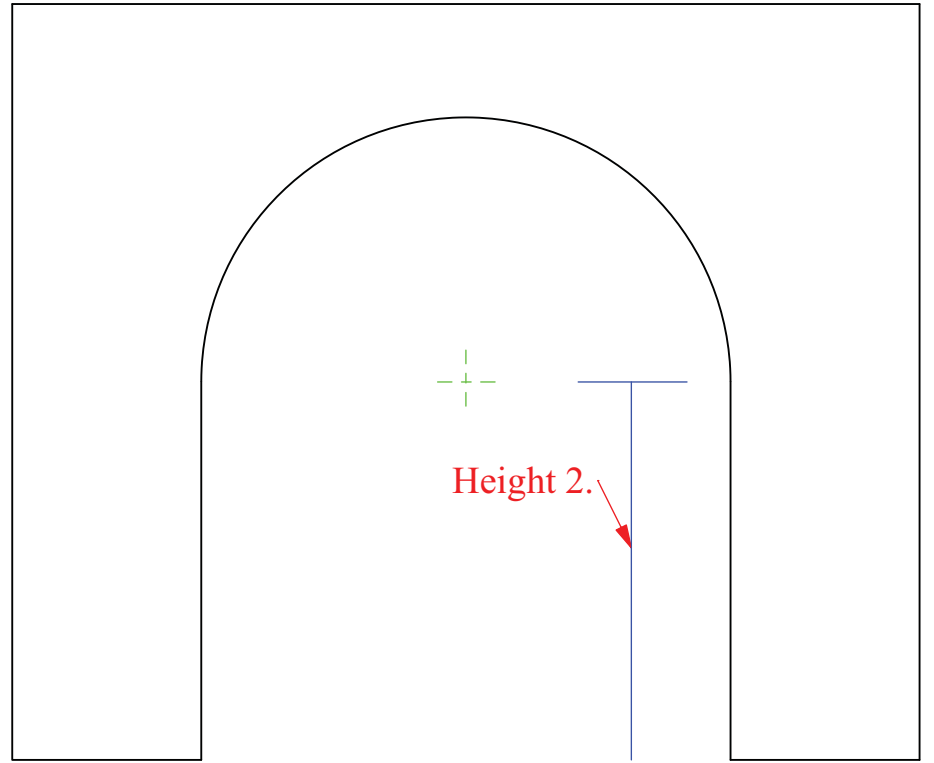

ELEVATION

Height 1.

Height 2.

Vanishing point

Horizon line

Ground line

Edge view of picture plane

The plan and elevation of a model arch are shown. The location of the picture plane, spectator, horizon line and vanishing point are also given.

Draw the perspective view of the arch.

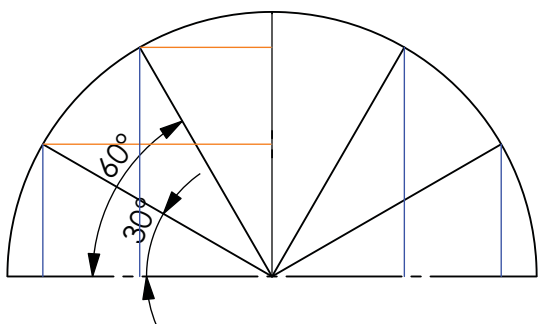

Spectator



DESIGN & COMMUNICATION GRAPHICS

PERSPECTIVE PROJECTION 7

Name: _____ Date: _____

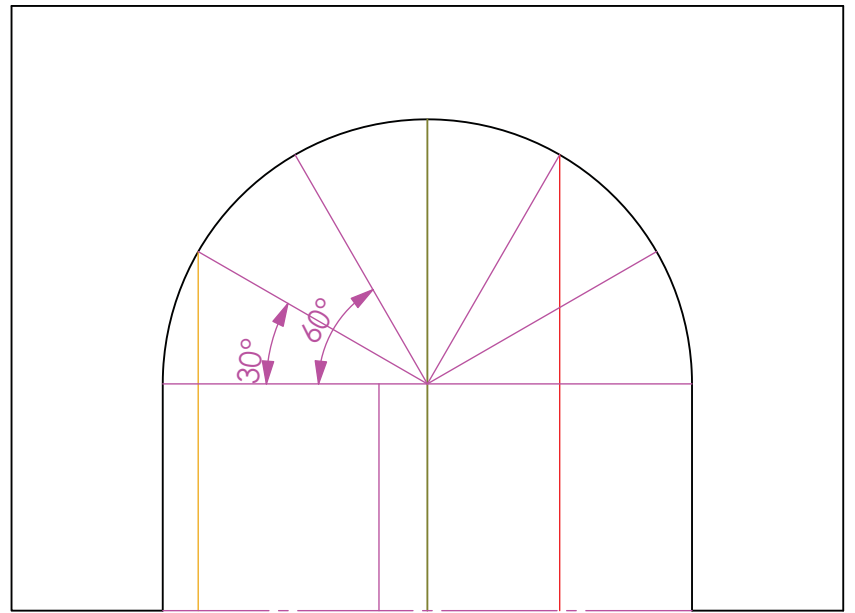

ELEVATION

The plan and elevation of a model arch are shown. Make a perspective drawing of the arch when the position of the spectator is as shown, the picture plane is located 60mm from the spectator and the horizon line is 40mm above the ground line.

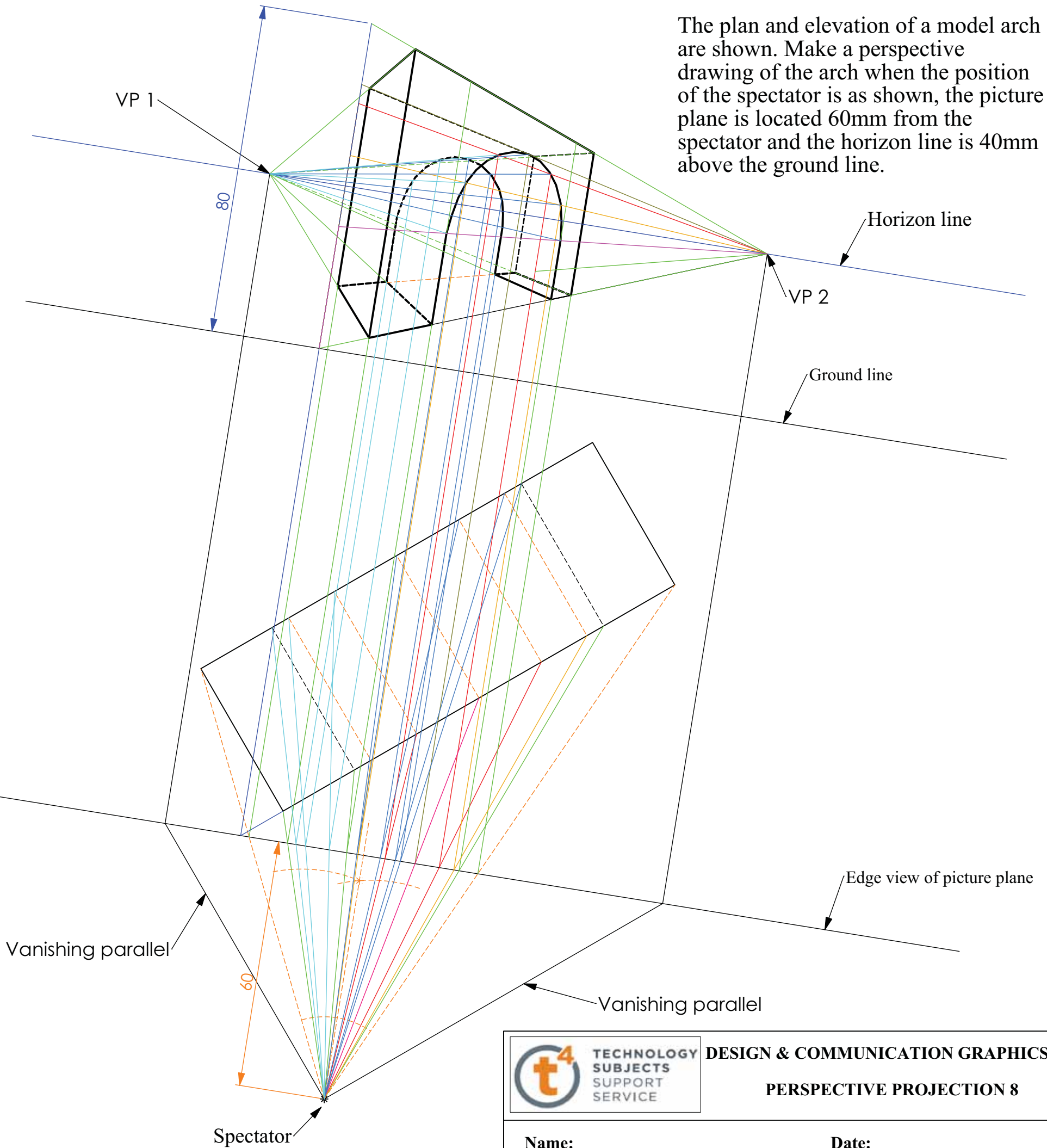

Name: _____ Date: _____

The plan of a model of a house, the position of the spectator and the plan of the picture plane is shown in Fig. 1. The end elevation of the object is shown below.
 The height of the horizon line is 15mm above the ground line

Complete the perspective view of the model by locating a third vanishing point for the lines inclined at 30 degrees.

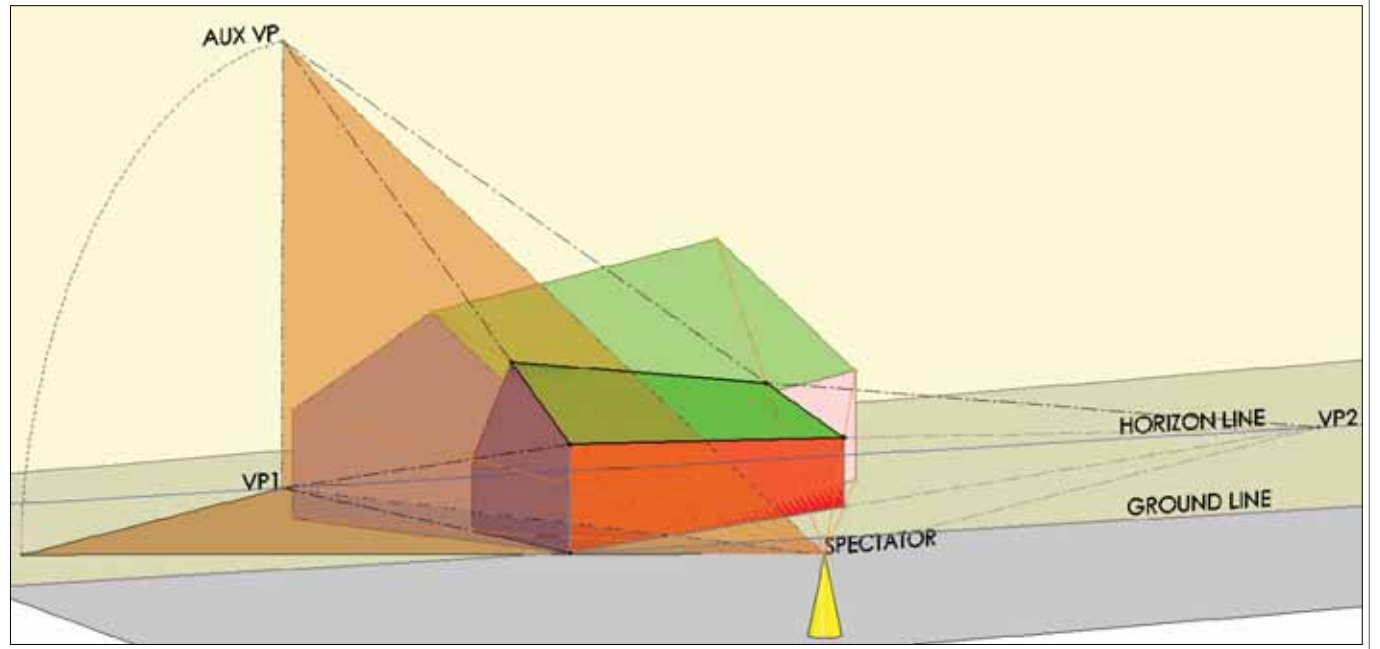
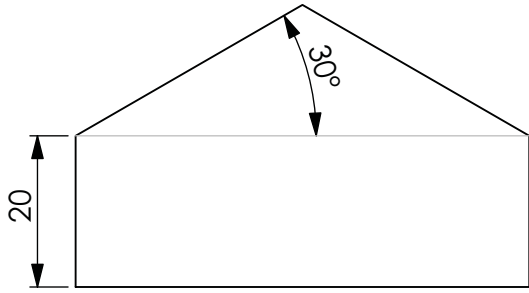

(3D View not to scale)

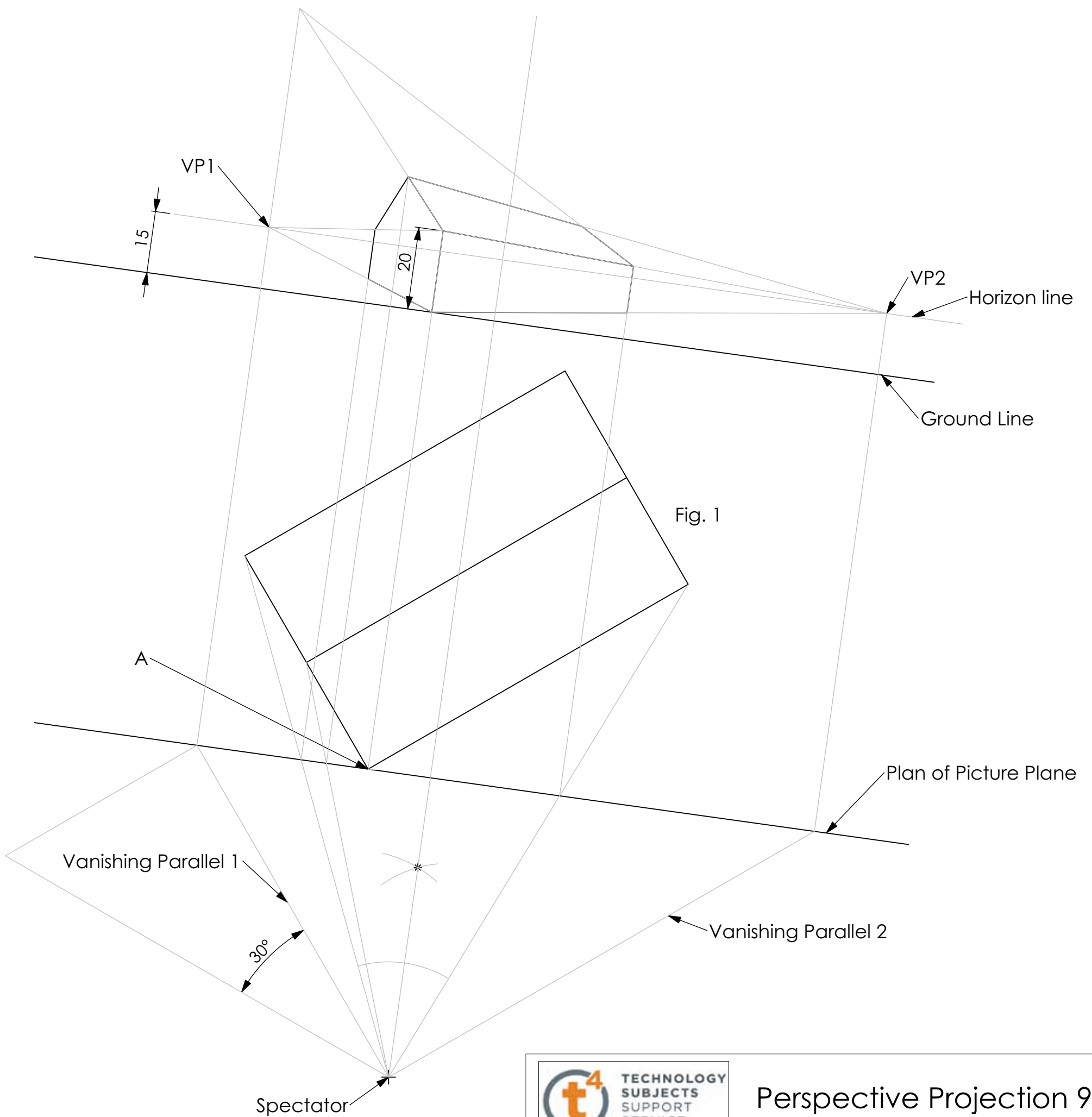



Draw the perspective view of the house when the position of the spectator is as shown, the picture plane passes through the corner A and the horizon line is 25mm above the ground line. Use a vanishing point for the 40 degree sloping faces of the roof surface to determine its perspective.

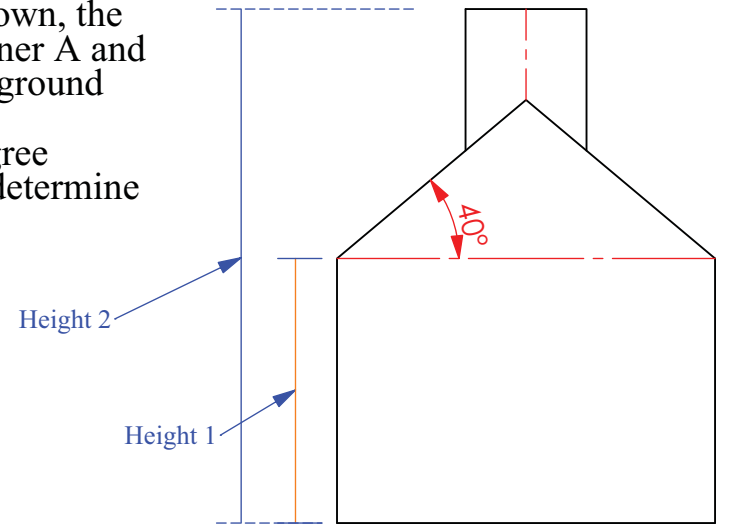

END VIEW

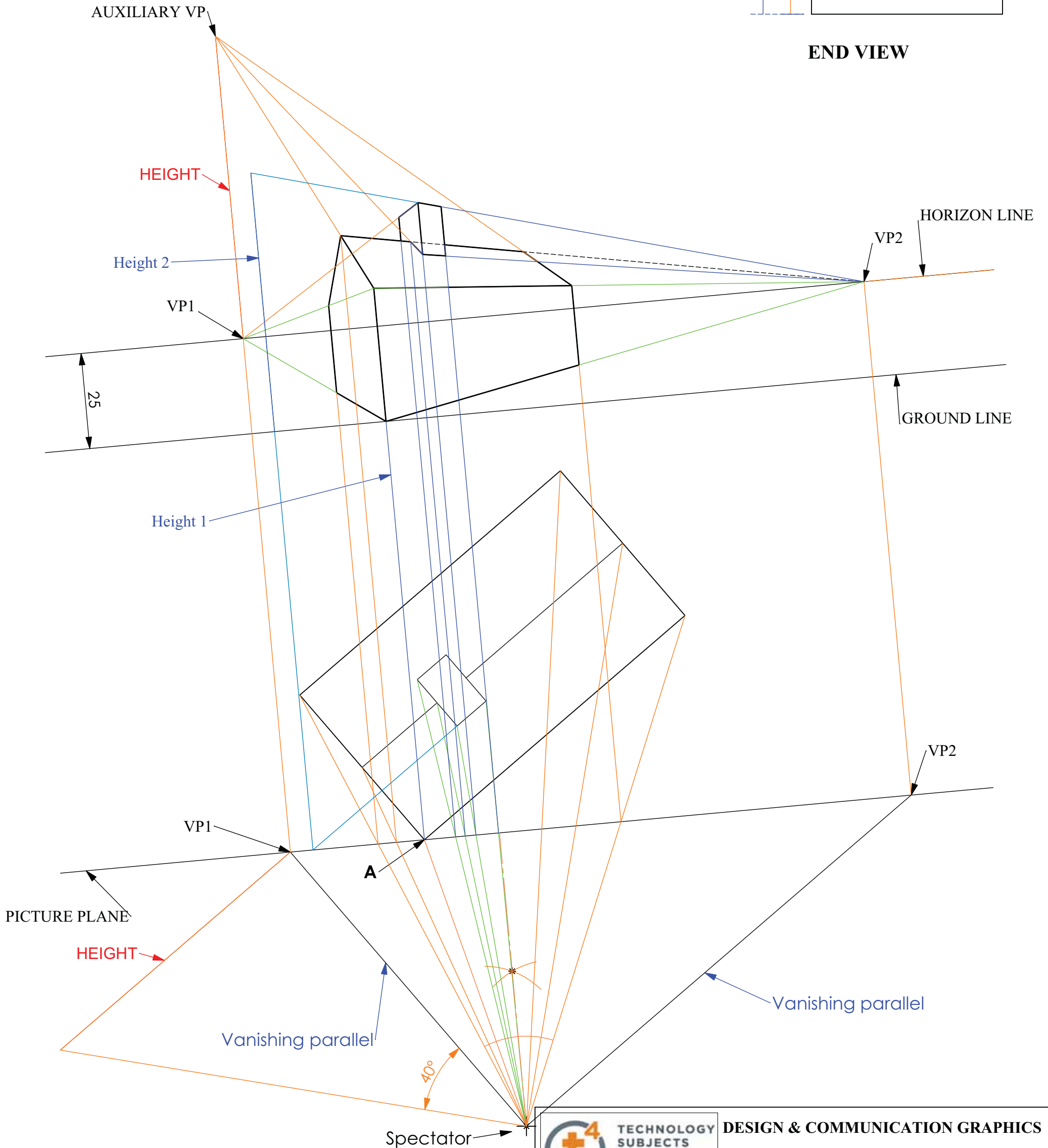



The plan and end view of a cigarette bin are shown. Make a perspective drawing of the bin when the position of the spectator is as shown, the picture plane touches corner A. The ground line is located 82mm from the edge view of the picture plane and the horizon line is 60mm above the ground line.

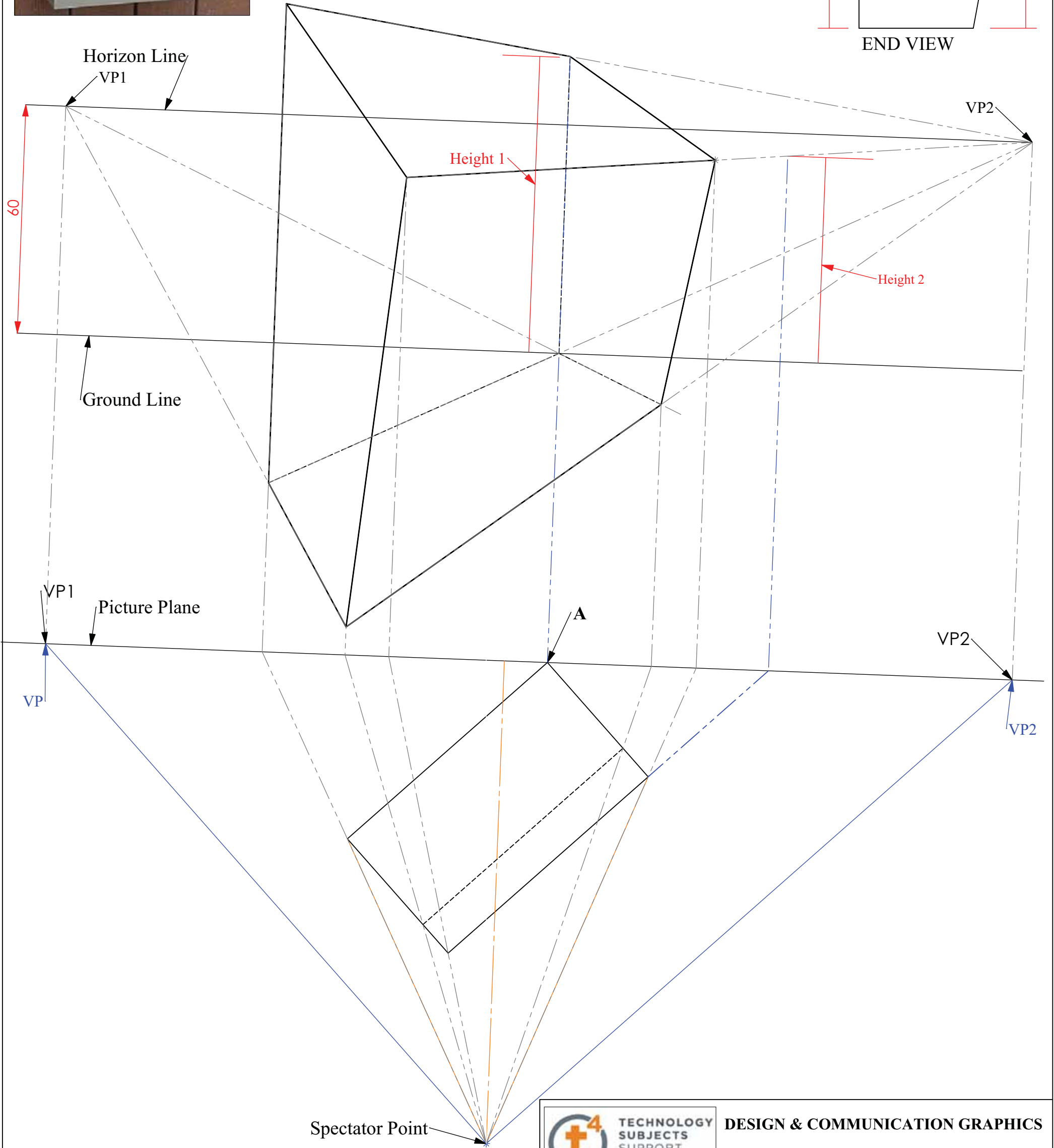
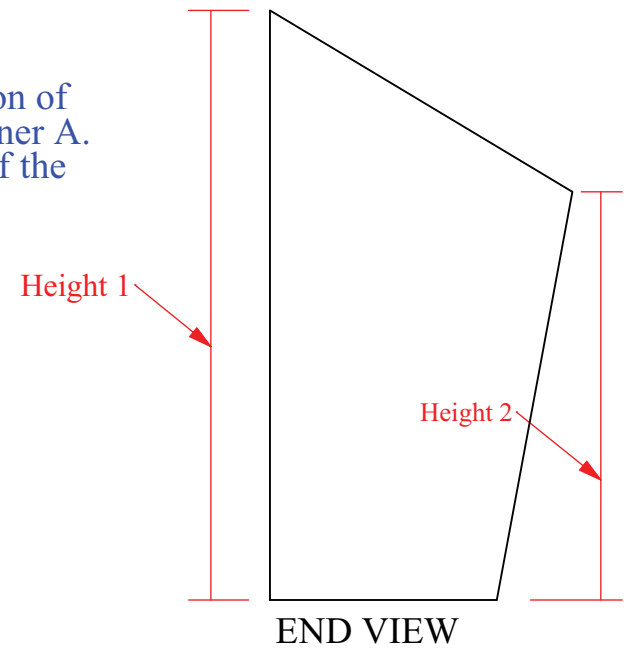



Height

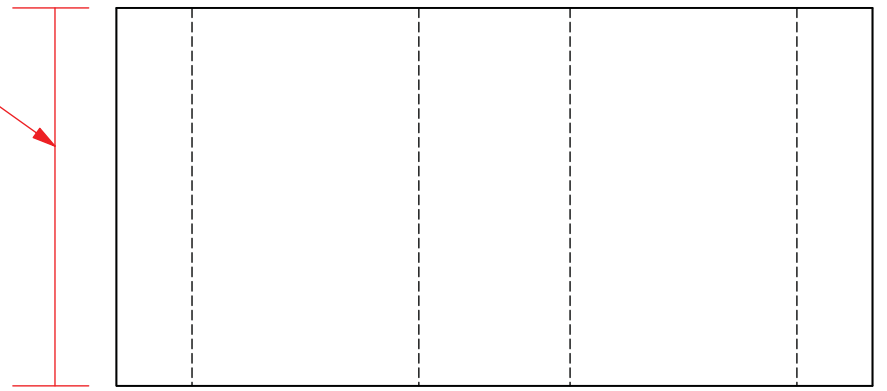

ELEVATION

Vanishing point

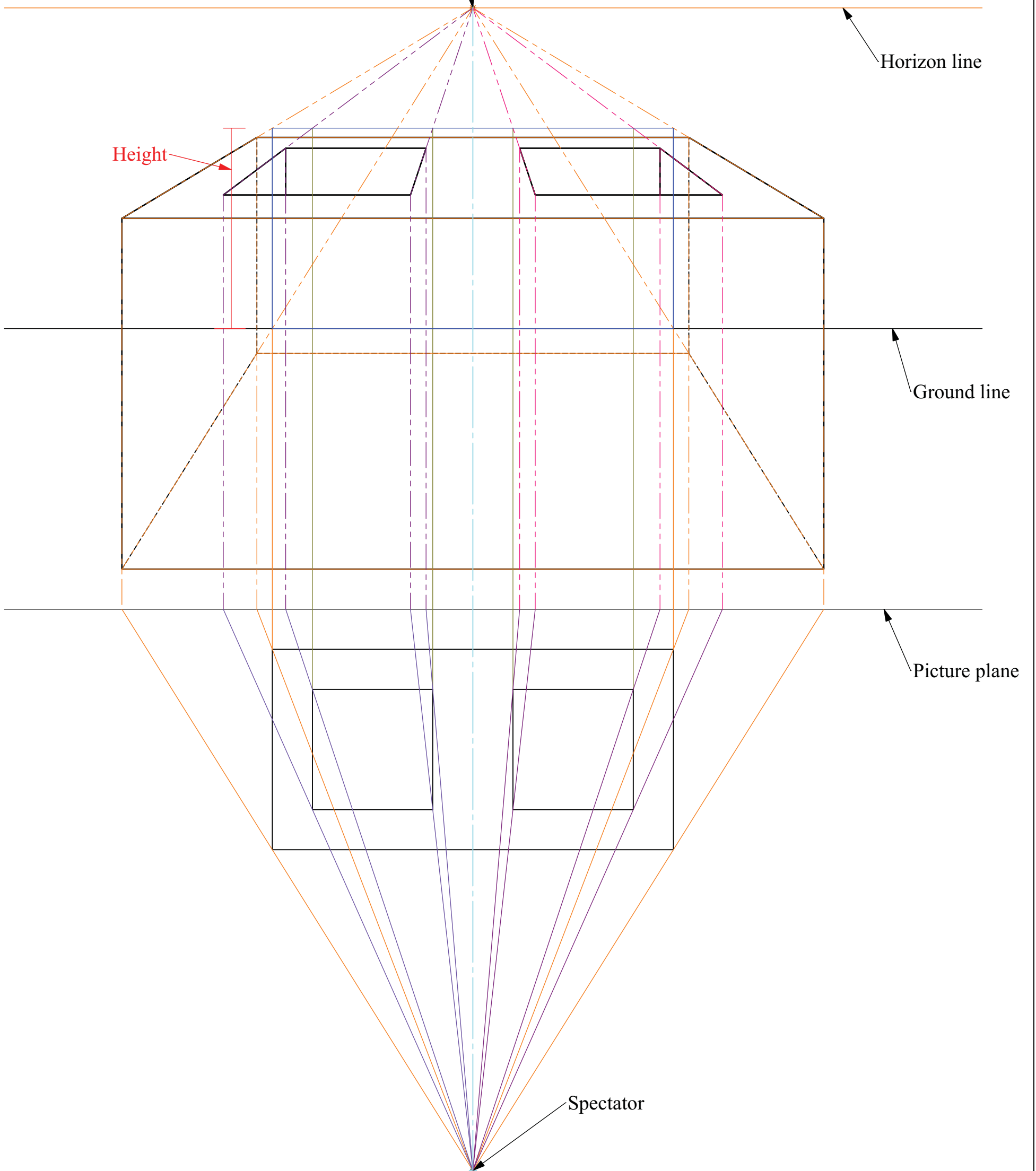

The plan and elevation of a cavity block are shown. Make a perspective drawing of the block when the position of the spectator is as shown. The picture plane, ground line, horizon line and vanishing point are shown.



TECHNOLOGY DESIGN & COMMUNICATION GRAPHICS

SUBJECTS SUPPORT SERVICE

PERSPECTIVE PROJECTION 12

Name: _____ Date: _____

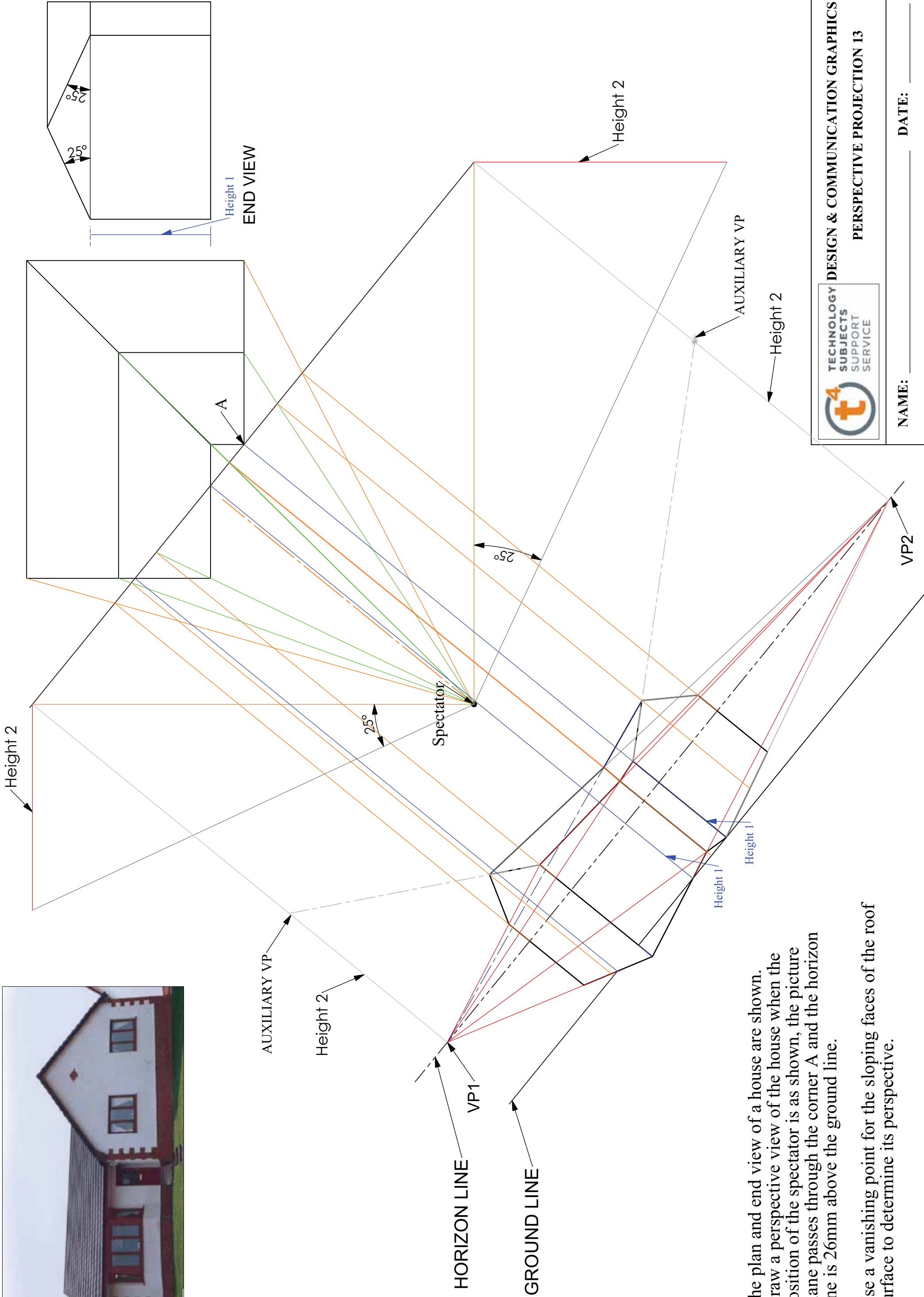

The plan and end view of a house are shown. Draw a perspective view of the house when the position of the spectator is as shown, the picture plane passes through the corner A and the horizon line is 26mm above the ground line. Use a vanishing point for the sloping faces of the roof surface to determine its perspective.



NAME: _____ DATE: _____

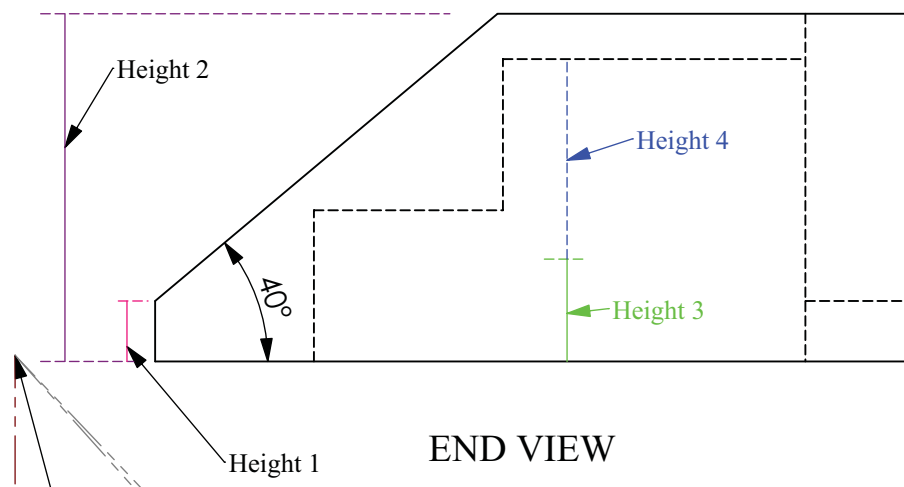

The plan and end view of internal steps are shown.
 Make a perspective drawing of the steps when the position of the spectator and picture plane are as shown. The horizon line is 70mm above the ground line.
 Use a vanishing point for the 40 degree sloping sides to determine its perspective.

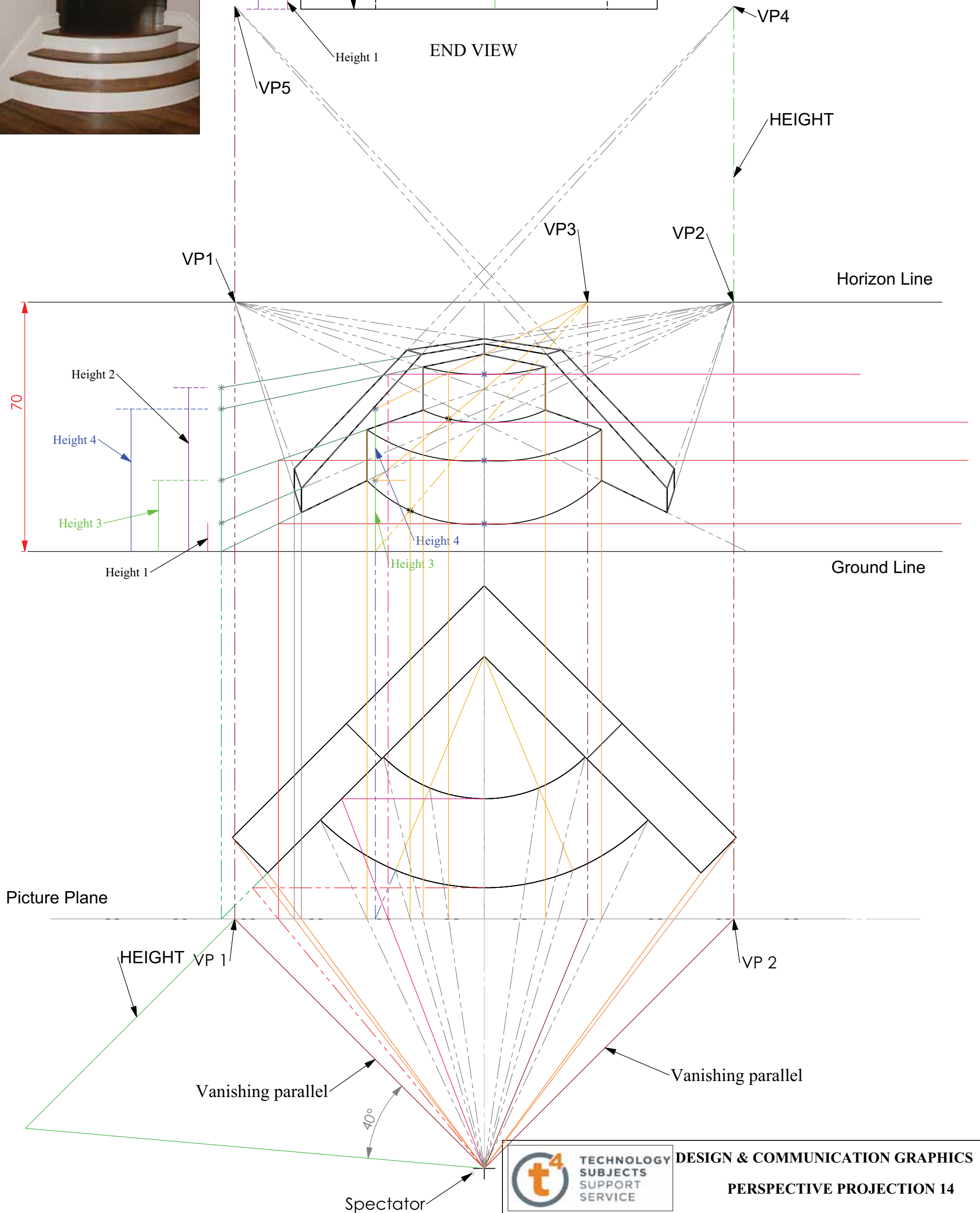

Name: _____ Date: _____